

(1) 平塚市

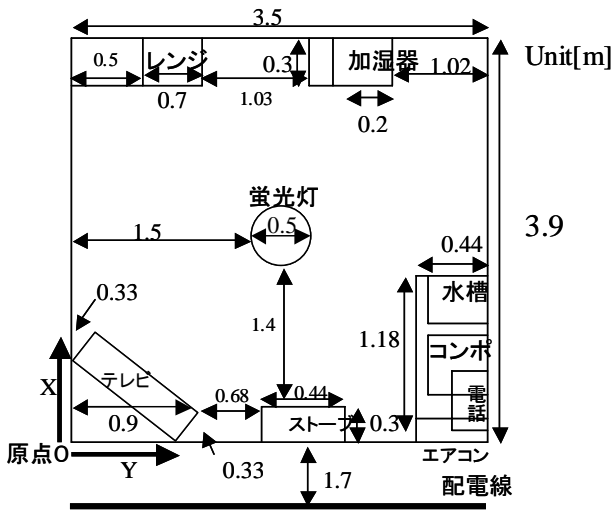

測定対象の部屋



電源 OFF

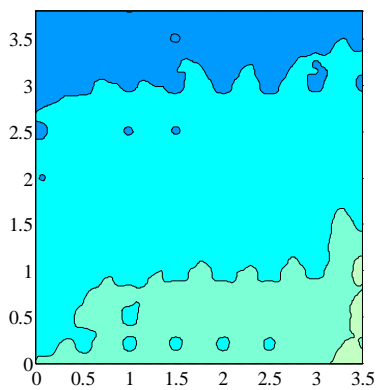

電源 ON

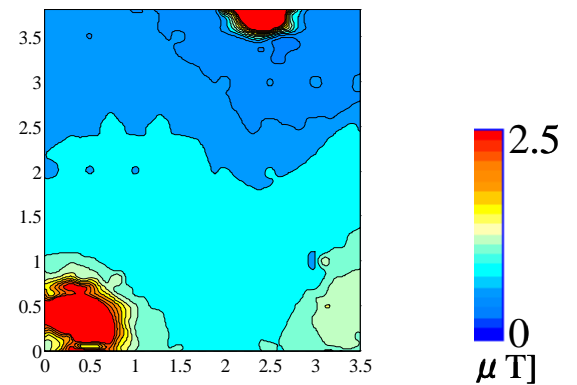

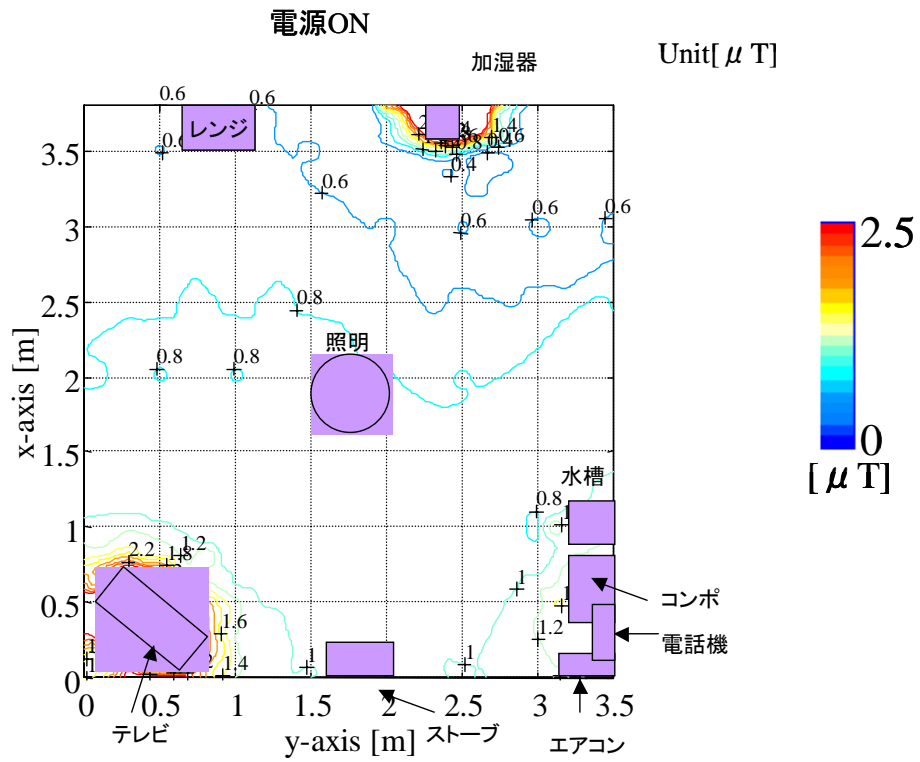
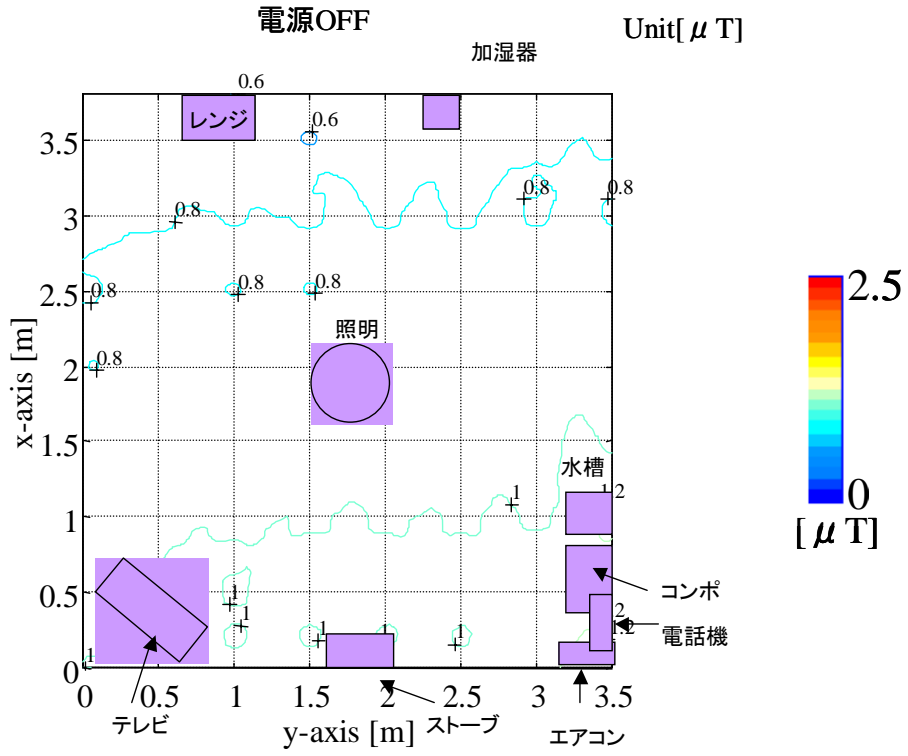

(2) 横浜

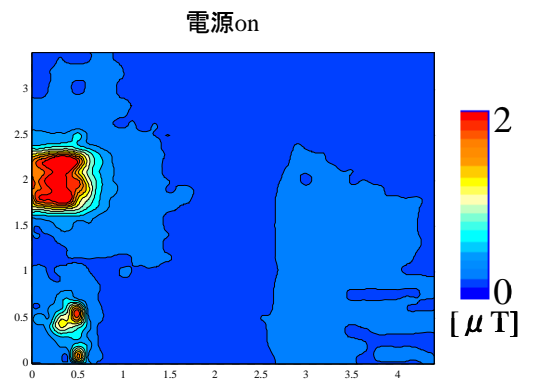
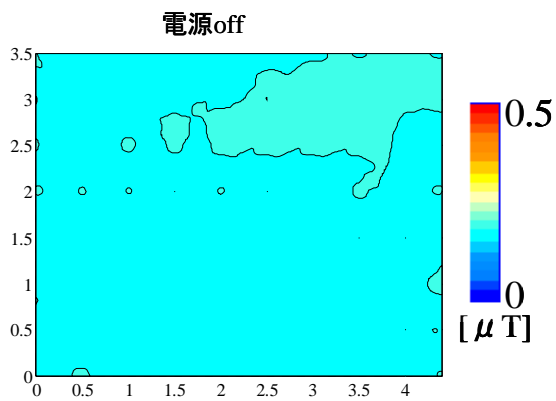
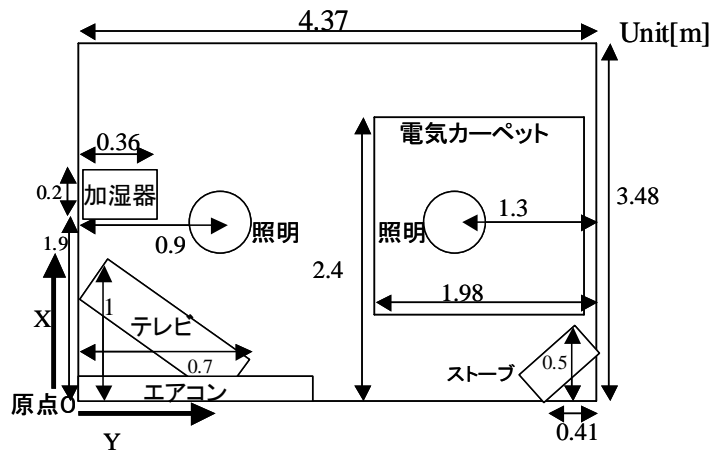

電源OFF

Unit[μT]

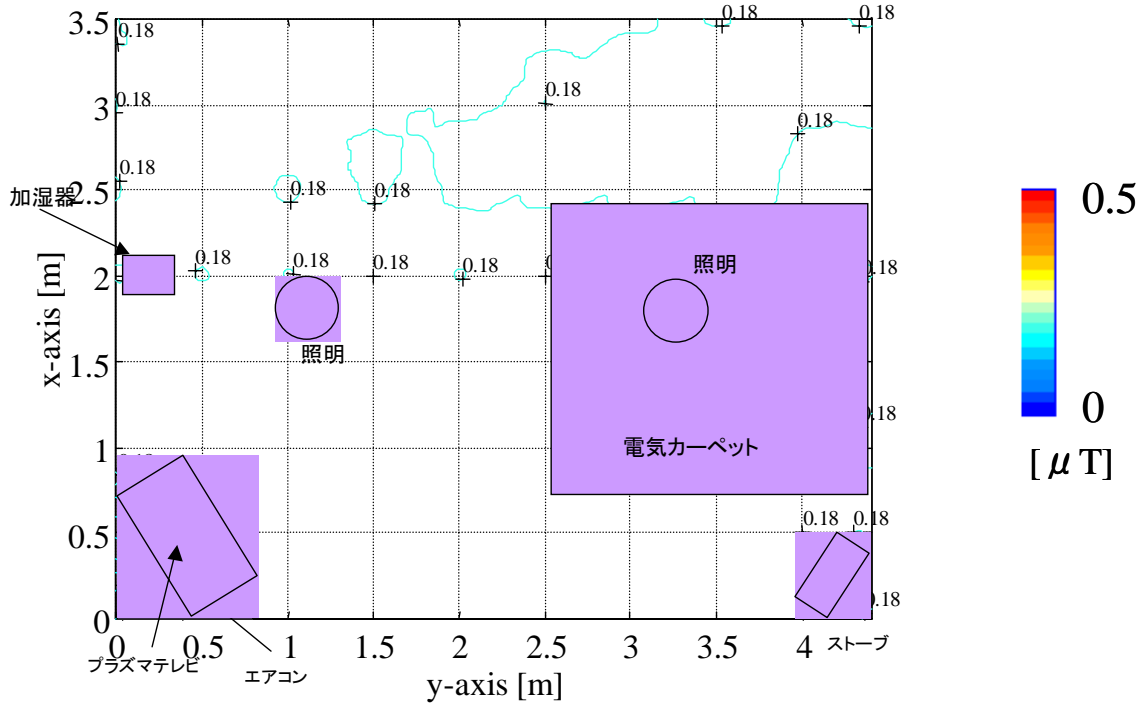

電源ON

Unit[μT]

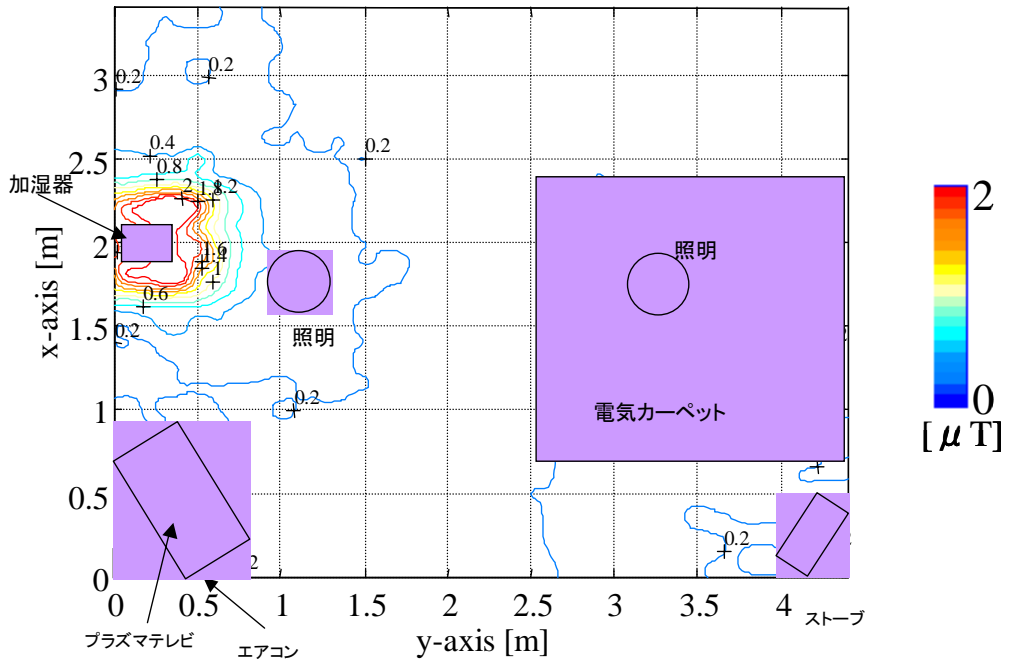

3) 吉川

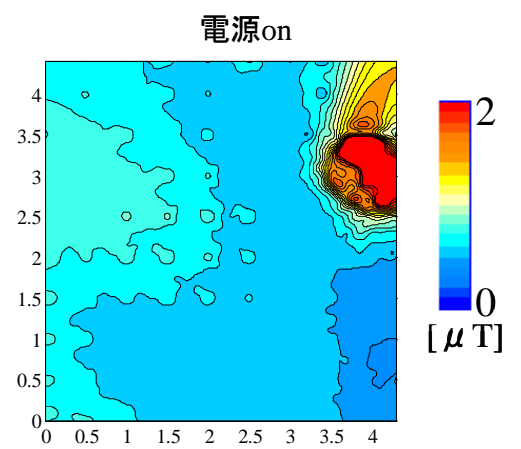
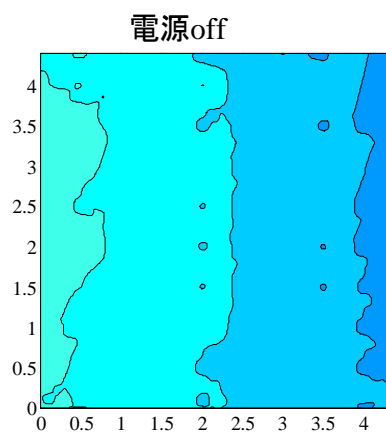
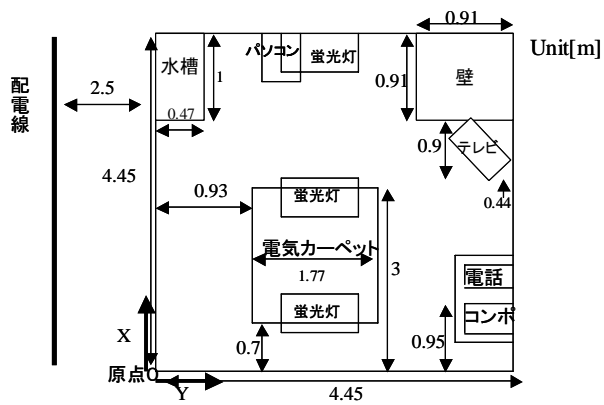

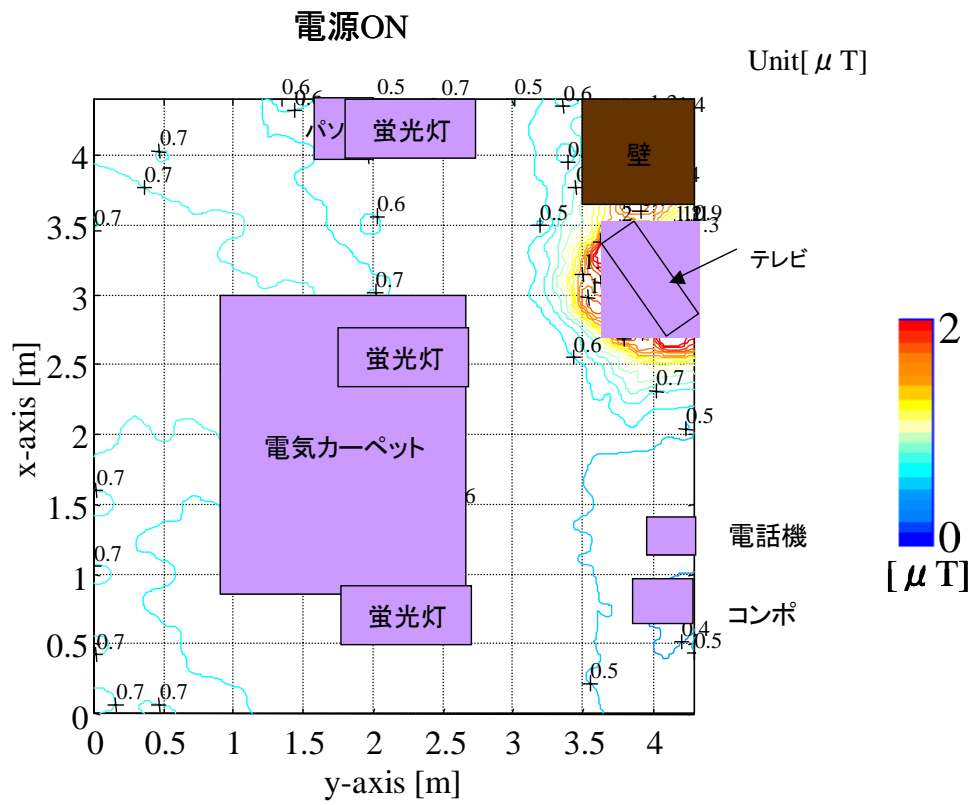
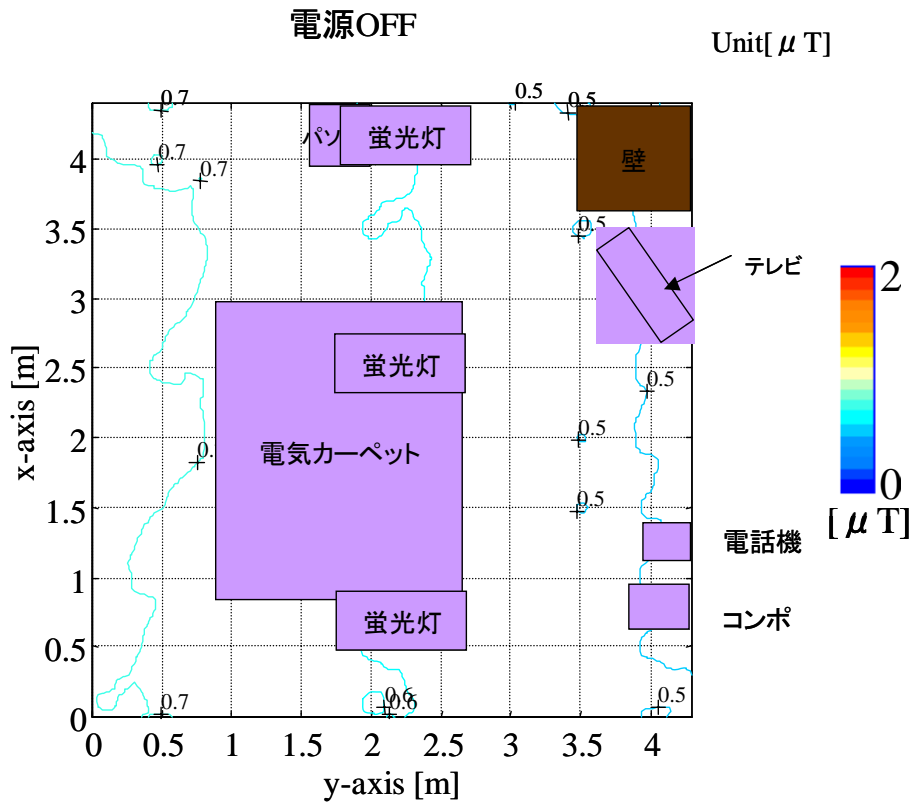

(4) 上原

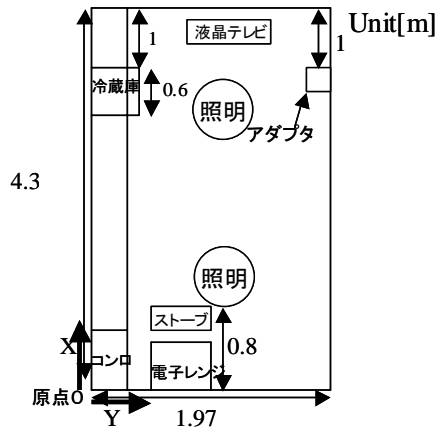

電源off

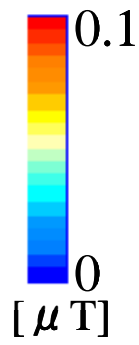
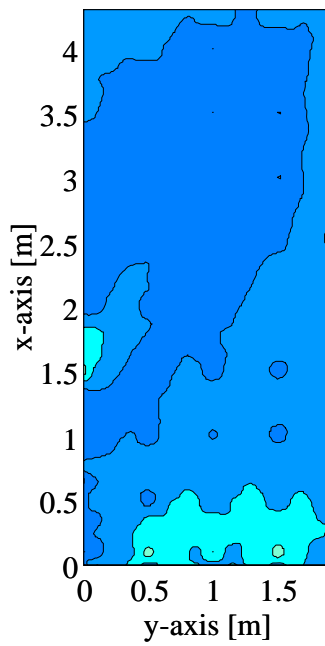

電源on

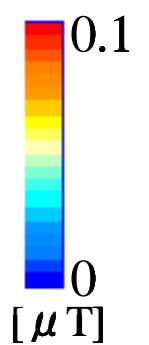
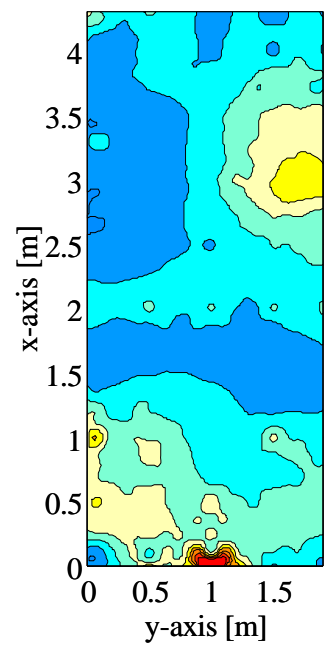

電源OFF

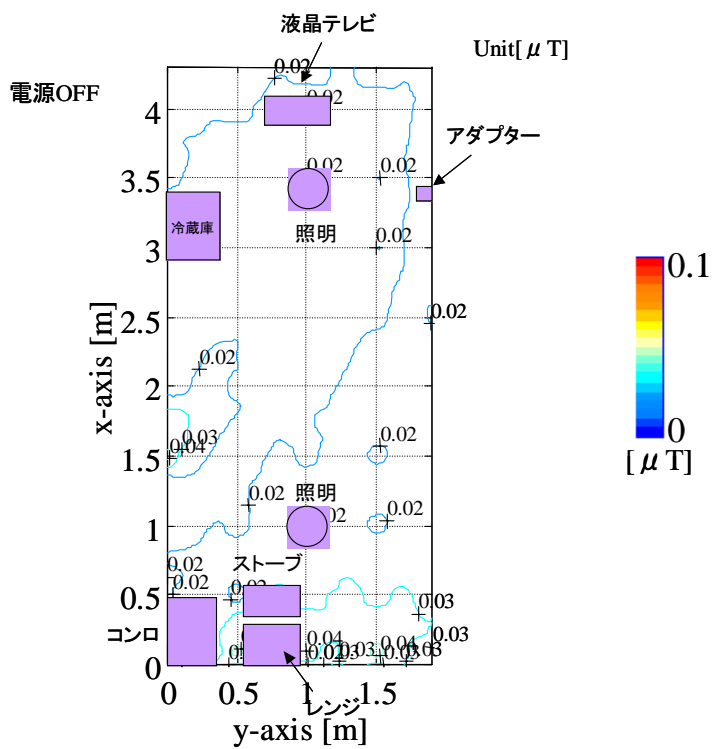

電源ON

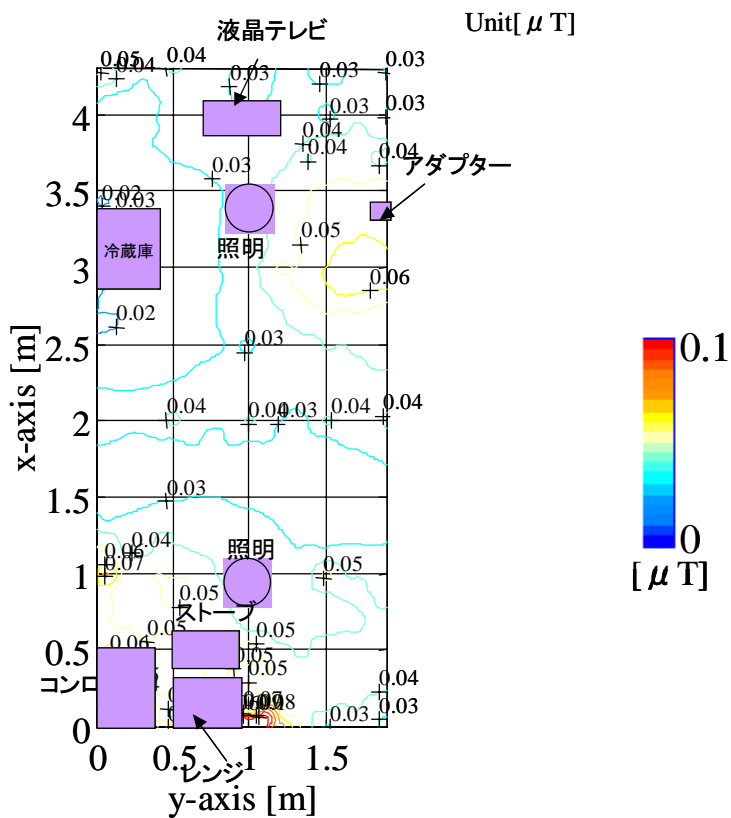

(5) 月島

