

FY 2002 Project Commissioned by  
Ministry of Environment, Government of Japan

# Technology Transfer Manual of Industrial Wastewater Treatment

March, 2003

Overseas Environmental Cooperation Center, Japan

## Foreword

This report was written to disseminate the knowledge and experience of industrial wastewater treatment technology accumulated over the years in Japan, as one part of an international cooperation project for environmental protection. Entrusted by the Ministry of the Environment in 2002, the Industrial Wastewater Treatment Technology Committee studied the scope and contents of the information provided by this report.

Japanese industrial production has been contributing to the domestic and global economies. We have learned that industry growth has risks for the local and global environments if appropriate pollution control measures are not taken. All industries should take care of environmental protection during the construction planning stage. Failure to do so will result in many expenses and difficulties that will emerge later for healing the environment.

Full-scale legislation of pollution control laws was prepared between 1955 and 1965, especially for the ten years of postwar industrial rehabilitation, although some local governments attempted positively to enforce pollution control regulations before that. Thereafter, the pollution concerns shifted from industrial pollution issues to the living environment and global environmental issues. Then the Basic Law for Environmental Pollution Control was drastically revised to become the current Basic Environment Law in 1993. The water pollution measures have been changing to cleaner production by means of reducing wastewater volume, saving resources, and saving energy, in addition to end-of pipe measures, during this period.

The Overseas Environmental Cooperation Center aims at worldwide support for spreading global environmental protection technology for sustainable economic growth. This time, the committee chose food processing wastewater treatment technology from the different industrial wastewater treatments in Japan and set out to provide a general description of the basic ideas, directions, and technology. This manual is to provide information on environmental technology for overseas. It has been comprehensively edited to provide knowledge of both administrative and technical information.

I will be glad if this report, which is based on experience with measures concerning industrial wastewater pollution control in Japan, proves of some use to people in countries involved in struggling with the same issues and contributes to preserving the global environment. I greatly appreciate every committee member and writer of the Technical Manual for the Industrial Wastewater Treatment for their contributions.

March 2003

Hiromi Mori

Chairman of Board Directors

Overseas Environmental Cooperation

## **Member of Committee of Technology Transfer Manual of Industrial Wastewater Treatment**

### **Chairman of the committee;**

Dr. Masataka Sugahara, Professor, Human Faculty, Osaka Sangyo University

### **Committee Member;**

Dr. Hiroshi Tsuno, Professor, Department of Environmental Engineering, Kyoto University.  
Director of Research Center for Environmental Quality Control

Dr. Akihiko Hogetsu, P.E. (Water Supply and Sewage, Comprehensive Technical Management), Senior Adviser, Shinko Pantec Co., Ltd.

Yositada Ogino, P.E. (Water Supply and Sewage), Managing Director, Environment Technologies L.P.C.

Takao Takemika, P.E. (Civil Engineering), Deputy Manager, Project Planning Department, Environmental Management and Technology Center in Kansai (EMATEC KANSAI)

## **Writers of the Manual**

Dr. Akihiko Hogetsu, P.E. (Water Supply and Sewage, Comprehensive Technical Management), Senior Adviser, Shinko Pantec Co., Ltd.

Yositada Ogino, P.E. (Water Supply and Sewage), Managing Director, Environment Technologies L.P.C.

Takao Takemika, P.E. (Civil Engineering), Deputy Manager, Project Planning Department, Environmental Management and Technology Center in Kansai (EMATEC KANSAI)

# Contents

## Part 1 General Description

Chapter 1	The object of this Manual .....	1
Chapter 2	Basic concept and direction of industrial wastewater treatment .....	2
Chapter 3	Environmental Consideration for Industrial Wastewater Treatment .....	3
Chapter 4	Water Area Conservation and Environmental Assessment .....	4
4.1	Environmental Assessment .....	4
4.2	Environmental Assessment System .....	5
4.3	Screening .....	5
4.4	Scoping .....	6
4.5	Environmental Impact Statement .....	6
4.6	Post Facto Assessment .....	7
Chapter 5	Production Process Improvement Judging from Industrial Wastewater Treatment .....	7
5.1	Wastewater Treatment by End-Of-Pipe Measures .....	7
5.2	Wastewater Treatment by Cleaner Production .....	8
Chapter 6	Environmental Control and Measures for Industrial Wastewater Treatment .....	12
6.1	Outline .....	12
6.2	Settlement of Environmental Quality Standards .....	13
6.3	Regulations by Relevant Laws .....	13
6.4	Observation and Administrative Measure .....	15
6.5	Establishing Pollution Control Systems in Factories .....	15
6.6	Subsidies and Others .....	16
Chapter 7	Selection of Wastewater Treatment Process and Technology .....	16
7.1	Wastewater Treatment System in Food Processing Industry .....	16
7.2	Process Selection .....	16

Chapter 8	The Construction Plan, Construction Costs, and Operating and Maintenance Costs for Industrial Wastewater Treatment Plants .....	18
8.1	Construction Plans .....	18
8.2	Costs for Construction, Operation, and Maintenance .....	18
Chapter 9	Wastewater Treatment Plant Design .....	18
9.1	Process Requirements .....	18
9.2	Basic Process Design .....	19
9.3	Detail Design .....	19
Chapter 10	Maintenance and Operation Plan of Wastewater Treatment Plant .....	20
10.1	Documentation .....	20
10.2	Plant Maintenance Plan .....	20
10.3	Labor-Safety-Hygiene Managing Plan .....	21
10.4	Environment Management Plan .....	21
10.5	Education Program .....	21
10.6	Operation Records and Accountability Procedures .....	22
Chapter 11	Water Quality Monitoring and Outline .....	22
11.1	Necessity of Water Quality Monitoring .....	22
11.2	Implementation of Water Quality Monitoring .....	23
11.3	Auto Water Analyzer for Water Quality Monitoring .....	26

## **Part 2 Basics of Technology**

Chapter 1	Outline of Wastewater Treatment Technologies .....	29
1.1	Unit Operation in Treatment Technologies .....	29
1.2	Treatment Systems .....	29
Chapter 2	Basics of Wastewater Treatment and Facilities Design .....	31
2.1	Purpose and Goal of Wastewater Treatment .....	31
2.2	Survey of Wastewater and Evaluation of Treatment Process .....	32
2.3	Design Considerations .....	34

Chapter 3	Conformity with Effluent Standards	35
3.1	Considerations on Environment Quality Standards	35
3.2	Effluent Standards	40
3.3	Discharge to Sewers	43
Chapter 4	Pretreatment Technologies	45
4.1	Screening	45
4.2	Oil Separation	48
4.3	Sedimentation	50
4.4	Dissolved Air Floatation	53
4.5	Coagulation	55
Chapter 5	Wastewater Purification by Biological Treatment	58
5.1	Aerobic Biological Treatment	58
5.2	Anaerobic Treatment	65
5.3	Hybrid Process by Anaerobic and Aerobic	72
Chapter 6	Advanced Treatment Process and Reuse	76
6.1	Removal of Residual BOD, COD, SS	76
6.2	Denitrification	78
6.3	Phosphorous Removal	83
6.4	Color Removal	86
6.5	Reusing Treated Water	88
Chapter 7	Sludge Treatment and Volume Reduction	89
7.1	Dehydration	90
7.2	Drying	94
7.3	Incineration	96
7.4	Composting	96
7.5	Sludge Reduction Process	98
Chapter 8	Control and Measure in Plant Operation	100
8.1	Aerobic Biological Treatment	100
8.2	Anaerobic Biological Treatment	103

## Part 3 Examples of Food Processing Wastewater Treatment

Chapter 1 Raw Food Material and Wastewater from Production Process .....	107
1.1. Products and Characteristics of Wastewater .....	107
1.2 Treatment Process Selection .....	107
Chapter 2 Beverages .....	110
2.1 Wastewater Volume and Qualities .....	110
2.2 Example of Actual Treatment .....	111
2.3 Considerations in Operation and Maintenance .....	112
Chapter 3 Breweries .....	113
3.1 Beer .....	113
3.1.1 Wastewater Volume and Qualities .....	113
3.1.2 Example of Actual Treatment .....	114
3.1.3 Considerations in Operation and Maintenance .....	117
3.2 Sake .....	117
3.2.1 Wastewater Volume and Qualities .....	117
3.2.2 Example of Actual Treatment .....	118
3.2.3 Considerations in Operation and Maintenance .....	120
Chapter 4 Oils and Fats .....	121
4.1 Wastewater Volume and Qualities .....	121
4.2 Example of Actual Treatment .....	123
4.3 Considerations in Operation and Maintenance .....	126
Chapter 5 Milk and Dairy Products .....	126
5.1 Wastewater Volume and Qualities .....	126
5.2 Example of Actual Treatment .....	128
5.3 Considerations in Operation and Maintenance .....	130
Chapter 6 Agriculture Product Processing .....	131
6.1 Wastewater Volume and Qualities .....	131
6.2 Example of Actual Treatment (wheat starch) .....	133
6.3 Considerations in Operation and Maintenance (wheat starch) .....	135

6.4	Example of Actual Treatment (potato starch) .....	135
6.5	Considerations in Operation and Maintenance (potato starch) .....	137
Chapter 7 Takeout Dishes .....		137
7.1	Wastewater Volume and Qualities .....	137
7.2	Example of Actual Treatment .....	139
7.3	Considerations in Operation and Maintenance .....	142
Chapter 8 Confectionaries .....		142
8.1	Wastewater Volume and Qualities .....	142
8.2	Example of Actual Treatment .....	142
8.3	Considerations in Operation and Maintenance .....	144



## Part 1 General Description

## Part 1 General Description

### Chapter 1 The object of this Manual

In Japan the Water Pollution Control Law and the prefectural stringent effluent standards set forth by the prefectural ordinances regulate the effluent from factories and other establishments. These regulations have helped to promote the development and use of excellent wastewater treatment equipment and systems in Japan. The effluent standards are set forth in accordance with the environmental conditions. The wastewater treatment process is decided to meet the effluent standards, while allowing for neighborhood circumstances, economics, operability, maintenance ease, extensions, and other such factors. Therefore, since it is difficult to provide a simple description of this optimum process, this manual describes technical aspects together with the background of the related laws, economics, and other factors, which should all be considered when any factory or other establishment plans to construct a wastewater treatment facility.

In section 1, the perspectives on global environmental conservation, effluent water regulations, economics, safety, and other aspects are mentioned in order to clarify the basic stance for wastewater treatment. In addition, the movements of environmental assessment, life cycle assessment, and related items are introduced to address the recent demands for accountability concerning the environmental impact caused by production. ‘No-regret’ strategies, including unproven ones, are required to address today’s environment conservation issues, in addition to economic evaluation, which has not always been sufficient.

In section 2, the fundamental technical aspects are described as references for constructing wastewater treatment plants, modernizing existing plants, and operating solutions for problems. References are provided as much as possible for further study.

In section 3, various practical results from wastewater treatment in the food processing industries are introduced. The facilities, equipment, and technologies introduced here are simply examples as previously mentioned, since they should be carefully chosen to meet varied conditions including neighborhood circumstances and economics. As almost all the properties of the wastewater treatment systems including performance, economics,

maintenance ease, and operability are fixed when selecting the process, comprehensive and comparative study, including all the alternatives, is desired to choose the process.

## **Chapter 2 Basic concept and direction of industrial wastewater treatment**

Industrial wastewater control aims at decreasing the environmental impact caused by production. Nevertheless, production cannot avoid exerting a damaging influence on the environment. Some criteria for accessing this impact are also required. As one measure, the effluent control system should definitely be part of the corporate environmental control system. The corporate environmental control system is a plan to successfully implement a management policy for environmental conservation, which shall continue to be upgraded with the PDCA (Plan Do Check Action) cycle containing the following items:

### (1) Environment Policy

Make the purposes and goals of environmental conservation, regulations, and other pledges known to every one in the organization in order to improve the environment on an ongoing basis and to prevent pollution.

### (2) Implementation Plan

Review the organization in order to reach the goals, settle the environmental conservation purposes and goals, and the scheduling and investment of funds and manpower.

### (3) Implementation and Application

Clarify the working group, management responsibility, necessary training, communication rules, writing required, and action programs for emergencies.

### (4) Check and Correct

### (5) Review by Board Members

Today, an understanding that the wastewater treatment facility deserves part of the production lines is necessary. Further understanding of the responsibility for explaining the pollution load to the public, which is accountability for environmental control, is growing. These issues are reflected in the formation of environmental management programs, recycling, qualitatively acquiring ISO 14001 certification, quantitative life cycle assessment (LCA), and other such items. This means that wastewater treatment shall be comprehensively considered

as part of the environmental issues to be addressed, which include the green house effect, ozone layer depletion, acid rain, soil contamination, smells, vibration, and other important problems.

### **Chapter 3 Environmental Consideration for Industrial Wastewater Treatment**

The industrial wastewater treatment plant purifies the wastewater while consuming large quantities of energy and chemicals, and also generating excess sludge that burdens the environment. The life cycle assessment instructs how to quantitatively understand the environmental impact. For example, the environmental impact from the wastewater treatment can be counted by the effluent volume of BOD, COD, SS, and other such substances in the water areas, waste material volume carried out, carbon dioxide volume emitted, and energy consumption. As the environmental impact from industrial wastewater treatment is hard to evaluate using only one of these parameters, several appropriate parameters shall be selected to meet the local conditions. Meanwhile, if methane is recovered as a useful substance from fermenting organic matter in wastewater and used for fuel, the total energy balance at the factory is to be evaluated, taking the methane gas into account. When converting sludge to fertilizer, the economic evaluation is easy. If it is evaluated from the environmental impact perspective, however, then other environmental impacts, including the complicated transportation, shall be evaluated along with the comparison with alternative sludge disposal methods. Though these complications need to be simplified, the antinomy would cause the actual evaluation on the other side to be lost.

In recent years, responsible care, as part of the environmental management system, has become widespread among many enterprises internationally that are exploring it along with sustainable growth. Accordingly, the PRTR (Pollution Release and Transfer Register) was legislated on March 2,000 in Japan. This regulation aims at businesses estimating the quantities of chemical substances used or produced by them, that are released in the rivers, air, soil, and transferred in the waste, and then reporting that data to the central government for official publication. There are 354 substances that are designated as Class 1 substances and 81 substances designated as Class 2 substances. The PRTR applies to sewage and industrial waste treatment facilities/disposal services other than those of manufacturers. When transferring or supplying designated substances to other businesses, the transferring business shall provide the transferee, before the transaction, with information by means of MSDS (Material Safety

Data Sheet), which was regulated at same time, on the properties and handling of the chemical substances in order to prevent leakage into the environment. The Class 1 chemical substances are hazardous to human health and ecosystems and widely exist in the environment. The Class 2 chemicals are hazardous too, but the environment is exposed less to them than the Class 1 chemical substances. This applies to the coagulants, neutralizers, defoamers, and other chemicals used in wastewater treatment.

As mentioned before, the environmental impact caused by wastewater treatment shall be considered from various perspectives, which are summarized in Figure 1-3-1.

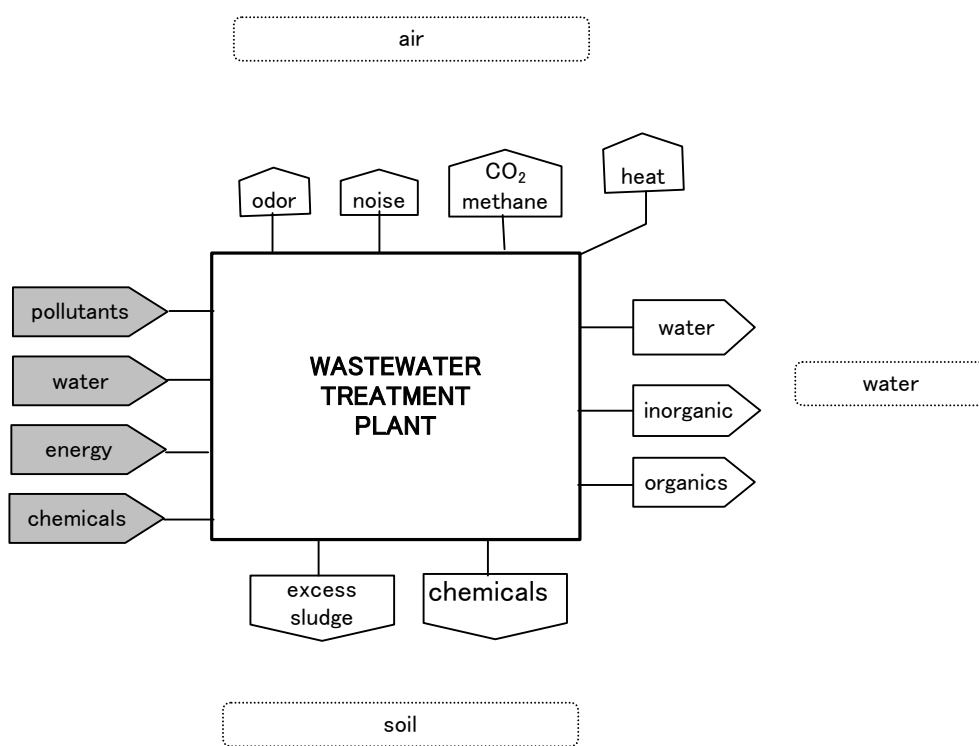

Figure 1-3-1 Consideration of environment impact at wastewater treatment

## Chapter 4 Water Area Conservation and Environmental Assessment

### 4-1 Environmental Assessment

The businesses that will impact the water areas, air, and soil must assess their impact on the environment and take the appropriate measures. The principle idea of the Environmental Impact Assessment shall mean the process of surveying, predicting, and

assessing the likely impact of a project; determining if it will be built; and if proper consideration is given to protecting the environment. In Japan, practical environmental assessment began in 1992 when the Cabinet decided on “Countermeasures against Environmental Pollution Caused by Public Businesses” and, following the overall enactment of the Environmental Impact Assessment Law in June 1999, prefectural and municipal governments legislated their own ordinances in compliance with the Law. The situation concerning environmental assessment drastically changed after that. The Environmental Impact Assessment Law is applied extensively to projects other than Class 1 Projects. Class 1 Projects are large-scale projects such as roads, airports, dams, power stations, and the like. The Environmental Impact Assessment Law was applied initially to Class 1 Projects, which include large-scale construction projects such as roads, airports, dams, and power stations. In years after, however, local governments enforced stricter standards by down-sizing the project scale, adding requirements, and widening the category for application. Therefore, in case of factory construction and facilities modification, implementing environmental impact assessment may be required in accordance with ordinances, which affects the cost and delivery term in the project.<sup>1)</sup>

#### **4.2 Environmental Assessment System**

The environmental assessment system is generally classified into two types of assessments, those conducted by the proponent and those by a third party. These are conducted at the planning stage (project assessment), commencement stage (business assessment), and business stage (post facto assessment) in consideration of the project progress. If a project is subject to the environmental assessment system, the project proponent shall fill in the ‘Environment Impact Evaluation Methods Report’ form and submit it to the prefectural governor, who sends it to the mayors of the local bodies involved, who then make it available for public review. Then, the proponent shall fully consider public opinion and fill in the ‘Environmental Impact Assessment Report’ form, prior to starting the project. If an environment impact investigation is required after commencing construction, then a post facto assessment shall be conducted.

#### **4.3 Screening**

Under the new Environmental Impact Assessment Law, if a project scale is above a

certain threshold level, the relevant administrative agency must assess the project, even if it does not meet the requirements set forth by the Law. This procedure is called screening. Some local governments apply screening to some Class 1 and Class 2 projects, while others assess all the projects whose scale is beyond the level determined by the Law without screening.

#### **4.4 Scoping**

Scoping means that the proponent decides the investigation items, investigation method, evaluation procedures, and related items, after fully considering the comments in the Environmental Impact Evaluation Methods Report. As to water pollution control, the water quality standards based on the Basic Environmental Law are stipulated for protecting human health and conserving living standards. The 26 substances such as heavy metals, chlorinated organic compounds, and agricultural chemicals are designated to protect human health, and 9 additional items such as pH, dissolved oxygen, suspended solids, biochemical oxygen demand, chemical oxygen demand, total nitrogen, and total phosphorus are designated for conserving living standards. The former standard is uniformly applied everywhere in Japan, and the latter is established for rivers, lakes, and coastal waters. The predictions for water quality changes in the effluent connected water areas are estimated by the effluent pollutant load as a qualitative approach, or by a computational diffusion model as a quantitative approach. Environmental assessments other than water pollution are for the air and an aquatic biota.

#### **4.5 Environmental Impact Statement**

The measures for environmental conservation shall be planned first. In this stage, the objects and goals for environmental conservation measures are clarified based on information during the scoping and investigation-prediction such as the basic policy of environmental conservation, business properties, local conditions, targets of local environmental basic policy, comments on the scoping document, and impact prediction results. At the next stage, countermeasures to avoid or reduce or compensate for adverse impacts shall be comparatively studied repeatedly, until the most appropriate implementation plan is selected. The plan should be studied in detail at each engineering stage including the location, layout, and size-structure; facility-plant and landscaping; operation and maintenance; and construction procedure. The environmental impact assessment should be made by the proponent stating whether the selected conservation measures can avoid or reduce the predicted impact.

#### **4.6 Post Facto Assessment**

The objective reasons shall be expressed in a statement by a proponent. If the impact assessment statements are judged as extensively uncertain concerning the effectiveness or influence of measures, or the impact on other environmental factors, then post facto assessment shall be conducted. The post facto assessment results and supplemental measures, if required, shall be made public.

#### **REFERENCES**

1. Research and Development Committee, Energy - Environmental Report (1999): Investigation Results of Environmental Assessment, Engineering Advancement Association of Japan

### **Chapter 5 Production Process Improvement Judging from Industrial Wastewater Treatment**

The pollution control measures have mainly been focused so far on satisfying the regulations regarding water, air, and waste materials emitted from factories in Japan. In addition to these 'end-of-pipe' measures, more comprehensive measures are desirable for pollution control, which include reducing waste material generation by improving production lines, which is called cleaner production, and saving energy and resources such as electric power and water.

#### **5.1 Wastewater Treatment by End-Of-Pipe Measures**

The pollution control measures at the end-of-pipe have been making great contributions to reducing the pollutants discharged into the environment by businesses. However, this accompanies an investment in production facilities, which constantly raises production costs with daily operations, maintenance, and depreciation expenses. The energy consumed and waste materials generated also burden the environment. To address these issues, enterprises shall implement environmental control for global environmental conservation along with security management for the safety of facilities and public reliability on top of economic management for delivery terms, costs, quality, and other such factors.



## 5.2 Wastewater Treatment by Cleaner Production

### (1) Cleaner production advantages

Cleaner production is a production system in which raw materials are re-selected, production technologies are reformed, and entire production processes are re-structured so that the energy consumption and waste volume can be reduced. This is also called in-process-technology. The pollution control measures accomplished by the in-process-technology in the past prove that production cost is reduced together with resources and energy savings. If it is introduced to developing countries, which need to invest their money effectively, it will become a part of useful and effective 'no-regret' strategies. As well known references for cleaner production<sup>1)</sup>, pulp industries in Japan produced about 13,000,000 tons per year of paper and cardboard in 1970 and discharged an estimated 2,200,00 tons of COD. In 1989, 19 years later, the annual production had increased to 26,800,000 tons, which ought to emit 4,500,000 tons of COD by simple proportional calculation. The actual discharged COD was estimated at only 200,000 tons. A total of 84% of the COD was decreased as follows. Cleaner production accounted for 58% of the reduction by improvements in the production process and another 26% was decreased by recovering the black liquor. If pollution control measures are solely taken at the end-of-pipe, a huge amount of money should be invested in wastewater treatment plants.

### (2) Approaching cleaner production

The latest measures for the environment tend to manage reducing environmental impact by corporations, including the board members. This is symbolized by the acquisition of the environmental management system of the International Standard Organization (ISO 14000 series). The independent relationships in the factory between the production and environmental management groups fulfill these functions from the inspection perspective such as quality assurance. This independence, however, obstructs the command of a bird's eye view of rationalization, according to the time and circumstances. The importance of the cleaner production measures is to comprehensively understand the material flow in the factory. For that, actual investigation of the volume of wastewater and effluent generated is necessary. In the investigation, the water, BOD, COD, SS, total nitrogen, and total phosphorous shall be counted for the volume going-in-and-out of the factory and the discharge at each discharge point shall be understood. The data obtained shall be weighed by a method such as the Pareto

Diagram, which can arrange the outlets in order of their pollutant rank and allow the factory to determine which discharge points should be prioritized. All the people working in the factory shall also learn the state of the pollutants discharged too. The material flow shall be analyzed using the items described in Figure 1-3-1. Based on this analysis, a feasibility study for the planned countermeasures should be conducted, properly considering the estimated cost, and then the execution of reduction measures shall be given priority according to their cost effectiveness.

### (3) Decreasing Input Materials

The raw material is usually selected to produce high quality goods swiftly at the lowest cost. Therefore, changing the raw material is not that easy for reducing the pollutants by using cleaner production alone. As the leakage of raw material shares a major portion of the pollutants in wastewater, however, changing raw materials could reduce the pollutant discharged. This is provided that the product value of the taste and other factors would not be affected, and that the total cost of production and wastewater treatment could generate an advantage.

### (4) Improving Production lines

The most effective method for reducing pollutants is improving the production process. The Food Recycling Law recommends recovering and recycling waste materials generated from the factory as solids, as much as possible. Some examples for reducing wastewater volume and pollutants are mentioned below including recovering and recycling waste materials.

#### 1. Daily Dish Processing<sup>2)</sup>

This factory recovers methane gas from a high concentration wastewater stream using an anaerobic treatment plant. The low concentration wastewater is treated with air-floatation added by coagulation and discharges it into the sewers together with effluent from the anaerobic treatment plant. The factory obtained ISO 14001 in 1999 and improved the separation of waste materials in the factory and significantly reduced the wastewater volume of the high concentration wastewater stream as shown in Table 1-5-1, working under the slogan of “Improve Effluent Quality.” In contrast, the low concentration wastewater increased its volume and pollutants. From now on, separated collection systems should be further developed and

improved. The merits of methane gas recovery will be raised by decreasing the low concentration wastewater volume and increasing the load to the digestion tank by feeding more high concentration wastewater. The factory succeeded in reducing wastewater volume and pollutants in the high concentration wastewater stream by improving the processing practices. For the low concentration wastewater, the further recovery of methane is planned by one option of reducing the water when further reducing leakage from the raw materials becomes difficult.

Table 1-5-1 Wastewater improvement at daily dishes processing

Item		Design Figures	Result (Average)
High concentration stream	pH	4.3	5.1
	BOD (mg/?)	2,310	1,860
	SS (mg/?)	550	927
	n-Hexane extr. (mg/?)	110	74
	Wastewater (m3/d)	1,050	600
Low concentration stream	pH	6.5	5.2
	BOD (mg/?)	760	1,340
	SS (mg/?)	130	468
	n-Hexane extr. (mg/?)	50	56
	Wastewater (m3/d)	550	650
Effluent	pH	5~9	7.2
	BOD (mg/?)	<200	70
	SS (mg/?)	<200	41
	n-Hexane extr. (mg/?)	<30	1.7
	Wastewater (m3/d)	1,900	1,300

Effluent includes 300m<sup>3</sup>/d of wastewater from machine room

## 2) Sake Brewery<sup>3)</sup>

The largest amount of pollutants comes from the rice-rinse processing in the sake brewery. This factory removes the rice bran with a rotary sifter without water after rice polishing. As a result, both the wastewater volume and pollutants from the rice-rinse processing are reduced, which leads to no sedimentation in the settling tank. The latest rice-rinsing machine can reduce the wastewater volume by recirculating used water. In this case, the wastewater concentration becomes higher and separating the sedimentation becomes easier. The wastewater volume from the rinsing process varies from one to two times depending on the operating procedures. The returned bottles are seldom washed at the sake-factory and are usually washed at the bottle rinsing factory, which usually, depending on the local conditions, discharges the wastewater with BOD of several mg/l at the highest into the sewers after pH adjustment alone.

### 3) Milk Product Factory<sup>4)</sup>

The equipment in this factory is washed in a sequence of pre-washing, internal-washing, acid-washing, semi-final-washing, and final-washing. The effluent from the final-washing is not reused because of the high contamination from the milk. The effluent from the final washing is reused for pre-washing. Although the effluent from the internal-washing was thought not to be reusable due to the detergent in it, the membrane filtration shown in Figure 1-5-1 made it possible to reuse 150 m<sup>3</sup>/day for make-up water for the cooling tower and rinse water.

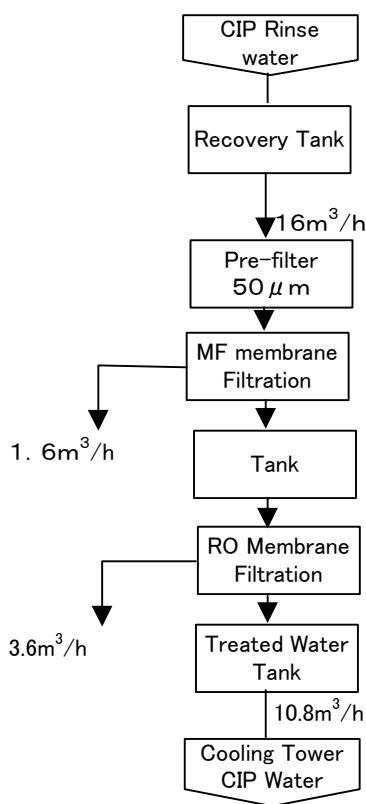

Figure 1-5-1 Wastewater recovery by membrane filtration

### 4) Confectionary Factory<sup>5)</sup>

This factory manufactures sponge cake and fruit jelly. In sponge cake production many eggs are consumed and the washing water from the egg-crusher is a main source of BOD. Compressed air is used to remove the remaining whites and yolks of eggs inside the machine, reducing 30% of the total BOD of the sponge cake production at the origin. In fruit jelly production, spilling syrup from cans causes major fluctuations in wastewater strength. Therefore, installing a spill wall for the whole can-opening working place is under study to

recover the spilled syrup.

Thus the reduction measures for pollutants are being done in various ways such as improving operating methods, changing processes, wastewater divided treatment, water recycling, and recovering spills as shown in the above examples.

#### (5) Worker Education

The important thing in cleaner production is to continuously improve the environmental management system using the PDCA cycle mentioned in chapter 2, for which the driving forces necessary are the training, self-consciousness, and capabilities of the members in the organization. Motivation and incentives are important factors to make the members of organizations aggressively tackle improvement.

#### References

- 1) Pollution Control Technical Manual (Pulp and Paper Industry). Japan Environment Corporation (1998).
- 2) Fukushima, T. Daily Dishes, The Most Appropriate Treatment Handbook for Food Processing Wastewater. Science Forum. (2002)
- 3) Watanabe, T. Sake, The Most Appropriate Treatment Handbook for Food Processing Wastewater. Science Forum. (2002)
- 4) Yazaki, M. Milk Products, The Most Appropriate Treatment Handbook for Food Processing Wastewater. Science Forum. (2002)
- 5) Ohnishi, M. Confectionary, The Most Appropriate Treatment Handbook for Food Processing Wastewater. Science Forum. (2002)

## **Chapter 6 Environmental Control and Measures for Industrial Wastewater Treatment**

### **6.1 Outline**

In order to prevent pollution from industrial wastewater, the amount of pollutants discharged into the water areas shall be reduced as much as possible, which is reducing the points generating pollutants as well as reducing the pollutants at each generating point. To realize the above mentioned goals, the establishment of the Environmental Quality Standards

(EQS) based on the Basic Environmental Law, regulations based on the relevant laws, preparation of inspection and monitoring systems, planning pollution control programs, organizing pollution control systems in industrial plants, subsidizing pollution control facilities with public funds, optimizing project site conditions, developing industrial wastewater treatment technologies, and other actions were taken in the past. The national and local governments and relevant private sectors play their own roles to promote these actions.

## **6.2 Settlement of Environmental Quality Standards**

The Basic Environmental Law defines the basic concepts of environmental protection in order to promote the comprehensive preservation of the environment and make sure that environmental protection is well-programmed. The Law also defines the responsibilities of the national and local governments, executive agencies, and general public, and it specifies the basic conditions of environmental protection. Under the Law the governments shall set forth the desirable environmental quality standards regarding pollution in the air, water, and environment for protecting human health and preserving living environments. In the environmental quality standards related to water quality, the human health standard is uniformly applied to all public water areas. While the living standards set forth the standard figures of BOD, COD, nitrogen, phosphorus, etc. for each public water area for the segregated purposes of waters in rivers, lakes, and oceans, the Water Pollution Control Law and other related laws also stipulate taking the necessary measures to sustain said environmental quality.

## **6.3 Regulations by Relevant Laws**

### **1. Water Pollution Control Law**

The Water Pollution Control Law aims at protecting the health of the people and conserving the living environment by regulating effluents from factories in public water areas and underground waters, and by accelerating the implementation of domestic effluent measures and other measures. Two types of regulations were set out. One is uniformly applied all over Japan according to the effluent water concentration, and the other is applied to designated enclosed water bodies to protect the water quality according to the Area-wide Total Pollutant Load Control. The effluent standards regulate the concentration of effluents from factories and other establishments into public waters. The facilities which discharge the

polluted water or wastewater are designated as Specified Facilities and the factories and other establishments which possess the Specific Facilities are called the Specified Establishments, where effluent is regulated by the effluent standards. The Area-wide Total Pollutant Load Control, which was enacted in 1978 to reduce pollution in large enclosed water bodies, regulates the pollution load in the designated water areas in addition to the effluent standards. Currently the regions where the effluent flows from into the Inland Sea, Tokyo Bay, and Ise Bay are referred to as Designated Areas, where the related prefectures set forth the plans for total quantitative reduction of the pollutant load of COD, nitrogen, and phosphorus from the Specified Establishments in accordance with the Fundamental Policy for Reduction of Total Pollution specified by the Prime Minister.

## 2. Law Concerning Special Measures for Conservation of the Environment of the Inland Sea

The Law Concerning Special Measures for Conservation of the Environment of the Inland Sea stipulates the necessary items such as formulating an environmental conservation plan to accelerate measures effectively protecting the Inland Sea environment. In addition, the law aims at conserving the Inland Sea environment including special measures regulating the Specific Facilities; preventing the damage caused by eutrophication; and preserving the natural seacoast. This law applies to 13 prefectures including Kyoto, Osaka, and Hyogo where effluent was being discharged into the Inland Sea. There are approval systems for the Specified Facilities, and the conservation of the natural coast and so on are regulated. The areas discharging the pollutant load into the Inland Sea are regulated by the total allowable pollutant loads of COD, nitrogen, and phosphorus the same as with the Water Pollution Control Law.

## 3. The Law Concerning Special Measures for Conservation of Lake Water Quality

The Law Concerning Special Measures for Conservation of Lake Water Quality aims at contributing to sustain a healthy and cultural life for the people by protecting the lake water quality from contamination by polluted water and wastewater by means of formulating the basic policy on related facilities and regulating the effluent qualities. This law allows designating lakes where the environmental quality is not currently being conserved, or deemed to be in danger of getting seriously worse, as Designated Lakes, which require special comprehensive measures. A total of 10 lakes including Kasumigaura and Biwa are designated. The load control for COD, nitrogen, and phosphorus is applied to these 10 lakes.

#### 4. Sewage Law

The Sewage Law stipulates a general sewer construction program for each area. The law also stipulates the management criteria for constructing the public sewers, river–basin sewers, and urban storm drainage systems, as well as their operation and maintenance, aiming at the conservation of public water quality, sound urban development, and upgrading public hygiene by constructing sewers. There are three types of sewer systems, which are public sewers, river–basin sewers, and urban storm drainage systems. When industrial wastewater discharged into public sewer or river–basin sewer systems is in danger of disturbing the treatment plant functions or damaging the facilities, the responsible parties shall install pretreatment facilities in compliance with local ordinances.

#### **6.4 Observation and Administrative Measure**

##### 1. Water Quality Monitoring of Public Waters

The prefectural governors and Designated Cities' mayors monitor the water quality of public water all the time in accordance with the Water Pollution Control Law. The Ministry of the Environment subsidizes the cost for preparing a measuring plan and investigating water quality from among the necessary expenses to achieve monitoring.

##### 2. Effluent Observation

The government, prefectural governors, and Designated Cities' mayors call for reports from the factories and other establishments or conduct site inspections in compliance with the Water Pollution Control Law in order to check the observance of effluent standards. The prefectural governors and Designated Cities' mayors take the necessary administrative measures including improvement orders to the factories and other establishments based on the observation results.

#### **6.5 Establishing Pollution Control Systems in Factories**

The law regarding establishing pollution control systems in the Specified Establishments imposes a duty on them to assign general managers in charge of pollution control affairs, pollution control managers who have the necessary knowledge and skill for pollution control, and other persons.



## **6.6 Subsidies and Others**

For the construction of industrial pollution control facilities, part of the construction funds can be borrowed, under favorable conditions, from lending agencies including the Fund for Facility Modernization of Small to Medium Size Enterprises, Japan Finance Corporation for Small Business, and Japan Environment Corporation. Favorable treatment is also given regarding taxation on the investment.

## **Chapter 7 Selection of Wastewater Treatment Process and Technology**

### **7.1 Wastewater Treatment System in Food Processing Industry**

The pollutants in wastewater are removed by either the removal method using physical filtration or absorption, or the decomposition method using oxidation or reduction. The unit operations normally used for the amounts of pollutants in the wastewater treatment are shown in Figure 1-7-1. The selection of wastewater treatment units and conceptual processing systems for different types/qualities of wastewater are shown in Figure 1-7-2. The process performance is confirmed by batch tests, small-scale lab tests, continuous treatability tests on site, and other methods. When a wastewater treatment process has been used in many installations and sufficient data are available, the process and performance can be decided based on the wastewater quality analysis data. When a new process is adopted in a newly built factory and no test sample is available, wastewater from similar production systems will be referred to, or the wastewater quality will be estimated from the raw materials, production process, and yield rate. When a new treatment process is adopted or the volume and/or quality of the wastewater fluctuate largely, on-site continuous test plant operation to verify the performance is indispensable in order to avoid risks and evaluate economic efficiency.

### **7.2 Process Selection**

The wastewater treatment systems, having their own properties including reaction methods, equipment structure, equipment system formation, size, environmental friendliness, and shape, shall be selected to meet the local geographical and environmental conditions based on comprehensive evaluations including performance, economics, safety, and maintenance. When a factory is constructed in an area regulated by stringent effluent regulations such as near a town, for example, the process and equipment shall be selected to fulfill the

requirements for odor, noise, external appearance, and installation space along with the performance for effluent. Where less stringent regulations are applied and ample space is available, a simple process like a lagoon can be selected.

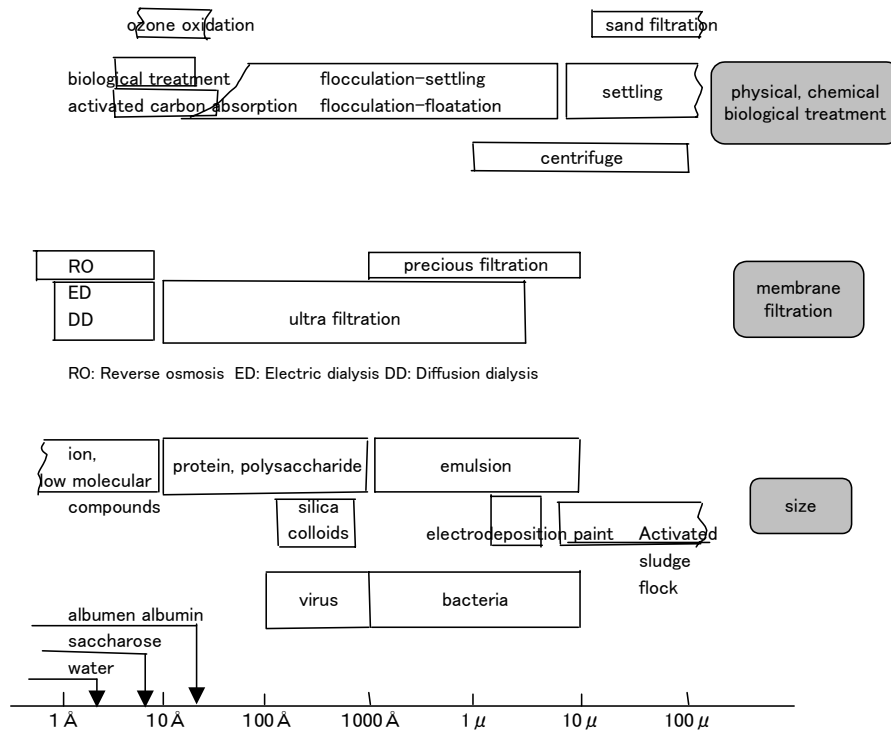

Figure 1-7-1 Wastewater treatment and pollutants particle sizes

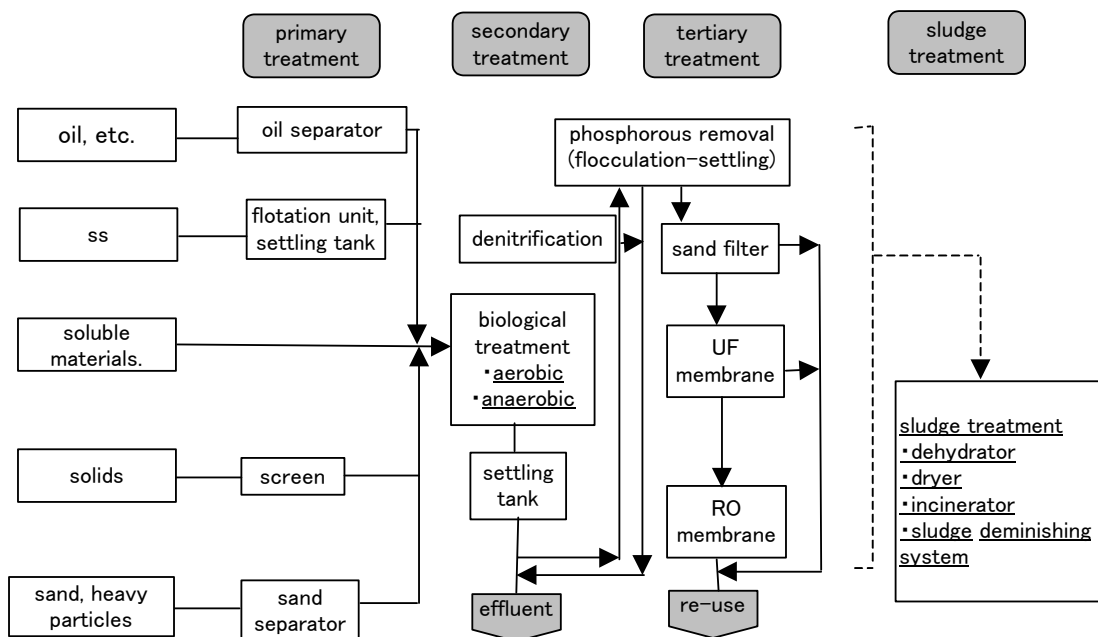

Figure 1-7-2 Wastewater characteristic and wastewater treatment

## **Chapter 8 The Construction Plan, Construction Costs, and Operating and Maintenance Costs for Industrial Wastewater Treatment Plants**

### **8.1 Construction Plans**

Each wastewater treatment plant runs continuously, keeping pace with factory production. To meet social needs, products are constantly improved and production processes are often streamlined, while the surrounding environmental conditions are also changing. Since predicting these changes when constructing the wastewater treatment plant is difficult and risky, the construction plan is generally prepared to meet both foreseeable changes and budgetary needs. From the viewpoint of environmental preservation, wastewater treatment is as important as production and stable operation of the wastewater treatment plant is vital to scheduled production. To achieve this, the properties of the wastewater, as well as the volume and daily and seasonal fluctuations of the pollution loads monitored by similar factories, should be studied in detail to increase responsiveness at the factory. In order to increase the reliability of the wastewater treatment plant, countermeasures should be developed to safeguard the factory against the predictable effluent deterioration and hazards caused by deviation from the normal pH, flow rate, concentration, pressure, and other factors based on the results of system safety analysis such as HAZOP (Hazard and Operability Study).

### **8.2 Costs for Construction, Operation, and Maintenance**

The economics, maintenance ease, easy operation, safety, and relevant items shall be considered at the planning stage of the wastewater treatment plant. The wastewater treatment plants last, incurring ongoing costs. It is important at the planning stage of a wastewater treatment plant to evaluate its life-cycle cost including construction costs, utilities consumption, repair costs, maintenance fees, and decommissioning costs. Fewer malfunctions, quicker repairs, and lower repair costs are important for easy maintenance.

## **Chapter 9 Wastewater Treatment Plant Design**

### **9.1 Process Requirements**

Attention to the economics and surrounding circumstances is necessary for projections for the wastewater treatment plant in addition to the functional purification design. Process design procedures secure all the functions of the wastewater treatment plant, for which the requirements and typical examination items are shown in Table 1-9-1. The relationships

between the security of technical reliability and economic requirements at this stage are mostly potential conflicts of interest that are called trade-offs. Each requirement is basically decided on the basis of economics.

Table 1-9-1 Design requirements and typical examination items

Requirements	Management items	Typical examination items	
Economics	Fixed charge	Depreciation Taxes, insurances Decommissioning cost	
	Fluctuation charges	Utilities consumption Maintenance cost Personnel expenses	
Securing technical reliability	Flow diagram	Material balance operating conditions PAD	These relationships are "trade-off". Each requirement shall be decided on the basis of economics.
	Equipments, piping	Corrosion Abrasion Operability, clogging Redundant equipments	
	Structure	Soil bear ability Structure, material Lightening, fire prevention	
Securing labor, safety and hygiene	Risks	Mechanical safety design (Fail safe) Leakage Fire	
	Operating circumstance	Noise Odor	
Environment conservation	Effluent Air	Effluent standards Exhaust gases	
	Soil	Leakage Chemicals---coagulation settling, dewatering	
Legal affairs	Plant, Safety	Building Standards Act Fire Services Act High Pressure Gases Control Act Laws on dangerous materials	Noise control regulation Labor Standard Act Safety regulation on boiler and pressure vessel Electricity Enterprise Act

## 9.2 Basic Process Design

The numerical design figures, layout, and equipment specifications, which are to be the basic data for designing the details, shall be confirmed at the basic process design stage. P & I flow diagrams, plot plans, and utility-flow diagrams are, for instance, major materials.

## 9.3 Detail Design

The quality, performance, operability, maintenance ease, safety, and other properties of the wastewater treatment plant are almost fixed at this stage. The construction starts off generally after the approval of the final drawings. Therefore, safety measures shall particularly be reviewed at this stage too. The usage of hazardous materials and dangerous places where risk of suffocation, being caught in machines, and other dangers exist in the wastewater treatment plant make safety measures important. As for safety measures, hazards (factors

causing risk) shall be specified at the design stage and countermeasures for risk should be considered. The principle of safety design shall be based on the fail-safe principle of mechanical design, and the introduction of the fool-proof method, which prevents failures caused by human errors with the reliability and safety of a mechanical system, is useful.<sup>1)</sup>

## **Reference**

1. A. Kumar. Analyzing System Safety. Pollution Engineering, p. 46, June (2000).

## **Chapter 10 Maintenance and Operation Plan of Wastewater Treatment Plant**

In wastewater treatment, it is very important to satisfy the effluent standards. In addition, businesses are recently being requested to take necessary measures for surrounding environmental conservation, clarifying environmental policy for global environmental conservation, and being accountable for the results. To secure these requirements, the stable operation of wastewater treatment is essential. The formalities of internal systems including criteria preparation, plant maintenance procedures, labor-safety-hygiene managing procedures, environment management procedures, education programs, operation records, and accountability are effective.

### **10.1 Documentation**

Documentation is vital to wastewater treatment plant operations and two types of documents should be prepared for daily operations and emergencies. Operating manuals, inspection-maintenance manuals, water quality management standards, reporting instructions, and other necessary items should be provided for scheduled operations. Documentation for emergencies should provide guidelines for actions in emergencies, including equipment malfunctions and heavy loads beyond capacity. For each type of emergency, first responders and responsible teams should be designated and appropriate training is needed. In general, the entire factory must respond to an emergency and emergency preparedness should be developed in conjunction with safety and environmental management.

### **10.2 Plant Maintenance Plan**

The maintenance level of wastewater treatment plants should be decided based on the purposes of the plants and cost-effectiveness. In general, the maintenance of production plants

is classified into the following four categories:

1. Preventive Maintenance: daily maintenance, regular inspection, and prognosis for the scheduling and methods of repair
2. Corrective Maintenance: correction to prevent further occurrence of a problem
3. Breakdown Maintenance: repairing a fault after it occurs
4. Maintenance Prevention: reflecting maintenance activities, upgrading the reliability of equipment and systems at the design stage

### **10.3 Labor-Safety-Hygiene Managing Plan**

Management of the safety and health of operators is important at wastewater treatment plants. The facilities, environment, operating procedures, etc. shall be maintained on a zero accident basis. This means that the organization must prevent accidents and take proper responses and measures against those accidents that do occur. The safety and hygiene management plan should also be developed to maintain workers' positive morale in addition to their safety.

### **10.4 Environment Management Plan**

The environment management systems at wastewater treatment plants shall be coordinated under the complete systems at the factory to satisfy effluent management and the management of waste materials, odors, exhaust gases, noise, etc. that are discharged. The management shall be compatible with the regulations in all respects. When products containing chemicals are sold or transferred, the MSDS (Material Safety Data Sheet) system, introduced together with PRTR, asks the supplier to inform the users about the chemicals' properties and the handling instructions before the transaction. The data sheet provides instructions for handling, storage, disposal, and transportation of chemicals as well as cautions related to toxicity for preventing leakage into the environment. Therefore, the user should check MSDS to confirm the safety of coagulants, neutralization agents, and other materials for use at wastewater treatment plants when they purchase chemicals.

### **10.5 Education Program**

The education and training programs, and the management of the operators working at wastewater treatment plants, are important. The required capabilities for plant operators

are to find problems to be solved, to fulfill their duties, to maintain good human relations, to solve problems, etc. The educational training is conducted through on-the-job-training, off-the-job-training, and self-development.

## **10.6 Operation Records and Accountability Procedures**

The water quality data, operating conditions, utilities consumption (electricity, water, chemicals, etc.), and maintenance records at the wastewater treatment plant shall consistently and continuously be recorded. This data shall be reviewed concerning process improvement and cost management, which contribute to economizing and environmental conservation. The stabilization of plant operation, rationalization, and accident prevention are improved by this data being analyzed by the quality control method. The importance of accountability for environmental load reduction activities is increasing for businesses who are profiting by utilizing the environment. Systematic reduction measures in the long term are becoming more important in addition to understanding the environmental load at the moment.

## **Chapter 11 Water Quality Monitoring and Outline**

### **11.1 Necessity of Water Quality Monitoring**

The effluent from the factories and other establishments into Public Water Areas is regulated by the Water Pollution Control Law, which prevents pollution in Public Water Areas in Japan. The reasonable regulations impose the minimum duty on businesses, which results in the water quality in public waters being conserved by the observance of regulations by businesses. Accordingly, the Water Pollution Control Law defines the wastewater causing pollution first, then designates the facilities discharging these wastewaters as Specified Facilities, and applies the regulations to the Specified Establishments possessing the Specified Facilities. The effluent from factories and other establishments is regulated either by “regulation based on concentration-oriented control” for discharge to the Public Water Areas or by “regulation based on total pollution load control” for discharge to the Specified Water Areas. For “regulation based on concentration-oriented control,” factories and other establishments willing to build the Specified Facilities must submit the details to the prefectural governor and are prohibited from discharging incongruent water into public waters. The businesses must additionally investigate, analyze, and record the effluent water quality by themselves (monitoring) in order to justify the situation. For “regulation based on total pollution load

control,” factories and other establishments in the specified areas are required to fulfill each area’s Area-wide Total Pollution Load Control and must measure and record the pollutant quantity in the effluent. Thus, businesses discharging industrial wastewater into Public Water Areas must monitor the effluent quality to understand the situation and check the conformity with the specified quality standards. The businesses can fulfill their responsibility by doing this.

## **11.2 Implementation of Water Quality Monitoring**

### **(1) Implementation of Water Quality Monitoring**

The water quality monitoring in accordance with the Basic Environment Law and the Water Pollution Control Law is broadly divided into two categories as shown in Table 1-11-1. One is the “monitoring effluent quality” done by businesses, and the other is the “monitoring water pollution in Public Water Areas” done by local public corporation entities. The “monitoring effluent quality” done by businesses is divided into two types. One is “monitoring based on concentration-oriented control”, and the other is “monitoring based on total pollution load control”. In addition, occasionally monitoring is conducted to support improving wastewater treatment. The “monitoring of water pollution in Public Water Areas” is to regularly monitor the pollution in the Public Water Areas (including bottom soil investigation), underground water quality, effluent quality of factories and other establishments (effluent monitoring from the Specified Establishments), and others items (aquatic life, nutrients, agricultural chemicals, chemical compounds, etc.).

### **(2) Method of Water Quality Monitoring**

#### **1) “Monitoring of Effluent Quality” done by Businesses**

As described previously, businesses are required to measure and record, by themselves, the effluent quality (concentration control) and pollutant load (total load control). While detailed measuring methods for the effluent quality (concentration control) are not specified, monitoring is necessary because the observance of the rules shall be reported to prefectural governors and city mayors upon their request, as well as to the inspectors when on-site inspections are made. The pollutant load monitoring methods for effluent are provided in detail, such as for COD as shown in Table 1-11-2.



Table 1-11-1 Implementation of water quality monitoring

Implementation	Classification	Category of monitoring	Applied laws
Enterprise	Monitoring on effluent standards	Monitoring in accordance with Effluent Standards	•Water Pollution Control Law
		Monitoring in accordance with Total Pollutant Load Control	•Law Concerning Special Measures for Seto Inland Sea
		Other monitoring (process management for improvement of wastewater treatment)	-
Local public corporation entities, etc.	Monitoring on water quality in Public Water Water	Regular monitoring of water quality in Public Water Areas (including bottom soil investigation)	•Basic Environment Law
		Regular monitoring of water pollution in underground water	•Water Pollution Control Law
		Effluent quality of factories and establishments (Monitoring of effluent out of Specified Establishments)	
		Other monitoring (aquatic life, nutrients, agricultural chemicals, chemical compounds, etc.)	

Table 1-11-2 Measuring methods of effluent COD load and intervals

Daily average wastewater volume	Measuring method			Frequency of measuring
	Object	Analyzing method	Remarks	
≥400 (m <sup>3</sup> /d)	Concentration	(1) Automatic water analyzer (COD analyzer, TOC analyzer, TOD analyzer, UV analyzer, etc.)	-	Every day, during discharging
		(2) Composite sampler and specified measuring method	In case that measuring method (1) is not appropriate	
		(3) Specified measuring method (composit sample of 3 or more sampling a day)	In case that measuring method (1) or (2) is difficult and prefectural governor approves	
		(4) Simplified analyzer		
	Wastewater volume	(1) Flow meter or flow velocity meter	-	
		(2) Accumulate volume meter		
(3) Simplified measuring method (JIS K0094. 8)		In case that measuring method (1) or (2) is difficult and prefectural governor approves		
≥200 <400 (m <sup>3</sup> /d)	Concentration	Either (1)~(4) Either (1)~(3)	-	One or more time not exceeding every 7 days of discharging period
	Wastewater volume	Either (1)~(4) Either (1)~(3)	-	
≥100 <200 (m <sup>3</sup> /d)	Concentration	Either (1)~(4) Either (1)~(3)	-	One or more time not exceeding every 14 days of discharging period
	Wastewater volume	Either (1)~(4) Either (1)~(3)	-	
≥50 <100 (m <sup>3</sup> /d)	Concentration	Either (1)~(4) Either (1)~(3)	-	One or more time not exceeding every 30 days of discharging period
	Wastewater volume	Either (1)~(4) Either (1)~(3)	-	

〈Calculation of COD load〉

$$L=C \cdot Q \times 10^{-3}$$

L: effluent pollutant load (kg/d)

C: COD concentration in specified effluent (mg/l)

Q: effluent volume of specified effluent (m<sup>3</sup>/d)

2) “Monitoring of Water Pollution in the Public Waters” done by Local Public Corporation Entities

The governors have a duty to regularly monitor the water quality in the Public Water Areas. An outline of monitoring procedures on river water quality is shown in Table 1-11-3 as an example. The examining methods are based on “Water Quality Investigation Procedure” (September 30, 1971, No.30, Kan-Sui-Kan).

Table 1-11-3 Monitoring of river water

	Investigation item	Frequency of Investigation	Frequency of sampling	Location of investigation	Others
Whole year investigation	Items for human health stipulated in EQS	≥ 1 day/month	4/day	Standard point and important spot for water usages	Conduct at stable state of effluent when fine days is continuing relatively  Basically collect samples at center stream of river. For wider river, sampling points shall be settled at both banks separately.
	Necessary items among Items for human health stipulated in EQS judging from state of pollution of effluent	According to circumstances	4/day	Necessary point judging from state of pollution of effluent	
	Items for living standards stipulated in EQS	≥ 1 day/month	4/day	Standard point and important spot for water usages	
Whole day investigation	Items for living standards stipulated in EQS	About 2 days/year	13 times at 2 hrs interval	Point with large daily fluctuation	Basically collect sample at point of about 20 % of water depth from surface
Interpolating investigation	Items for living standards stipulated in EQS	≥ 4days/year	4/day	Point requiring interpolation	Sampling time zone shall be considered at time of human activities, factory operation, pollutants drifting time, etc.

EQS : Environmental Quality Standards

### 11.3 Auto Water Analyzer for Water Quality Monitoring

In water quality monitoring, auto water analyzers are sometimes used due to the necessity of continuous measuring and for other similar reasons. Typical analyzers are shown in Table 1-11-4.

Table 1-11-4 Typical auto water analyzers

Items	Name	Measuring method, example	Principal of measuring, etc.
Water temperature	Water thermometer	Thermoelectric thermometry	Measuring temperature of liquid by thermoelectromotive force of thermocouple
pH	pH-meter	Glass electrode method	Measuring potential difference generated between relative electrodes in solution
Turbidity	Turbidity meter	Ratio of transmitted/Scattered light method	Measuring the ratio of transmitted/scattered light through solution
DO	DO meter	Membrane electrode method	Measuring oxygen in solution by membrane electrode of galvanic cell/polarography
Electric conductivity	Electric conductivity meter	Electrode conductometry	Measuring resistance of solution by electrode
Oxidation-reduction potential	ORP meter	Metal electrode method	Measuring oxidation-reduction of solution by metal electrode
COD	COD meter	Potassium permanganate titration/Potentiometric titration method	Measuring consumed potassium permanganate in solution, which oxidizes pollutant by potentiometric titration (ORP)
	TOC analyzer	Combustion catalyze oxidation/Infrared radiation absorption method	Measuring infrared radiation absorption by CO <sub>2</sub> generated from combustion of pollutant in solution
	UV meter	Ultra violet absorption method	Measuring transmissive ultra violet through solution, by which extrapolates COD comparing with COD measured by specified measuring method
Total nitrogen	Total nitrogen analyzer	Ultra violet oxidation method	Measuring ultra violet absorption of solution after oxidized solution by alkaline potassium peroxodisulfate/ultra violet
Total phosphorus	Total phosphorus analyzer	Ultra violet oxidation method	Measuring molybdenum blue absorption of solution after oxidized solution by alkaline potassium peroxodisulfate/ultra violet

## **REFERENCES**

- 1) Environment Law Research Committee: Environment Six Laws (2002 version). Chuo-Hoki-Shuppan (2002).
- 2) OECC: Outline of Technical Training Manual for the Conservation of Aqua Environment (1998).
- 3) Global Environmental Centre Foundation: Database of Technology of Continuous Water Pollution Monitoring in Japan (1995).

## Part 2 Basics of Technology

## Part 2 Basics of Technology

### Chapter 1 Outline of Wastewater Treatment Technologies

#### 1.1 Unit Operation in Treatment Technologies

Wastewater treatment technologies either remove suspended particles and dissolved substances from water, or convert them into harmless and stabilized materials. Treatment processes are classified into physical, chemical, physicochemical, and biological processes. The typical processes and removal methods are shown in Table 2-1-1. While the screened residues, separated oil, sludge, etc. generated during wastewater treatment are partly used for livestock feed, fertilizer, and other purposes, they are primarily reduced in volume by dewatering, drying, or incineration for disposal as industrial waste.

Table 2-1-1 Typical wastewater treatment processes and removal method

Treatment methods	Removal mechanisms	Typical processes
Physical Treatment	Screening Filtering Difference of gravity Thermo-energy Electric energy Reverse osmosis	Screen Filtration Settling , flotation Evaporation, drying Electrolysis Reverse osmosis membrane
Chemical treatment	Oxidation reaction Reduction reaction Double decomposition	Oxidation Reduction Neutralization, coagulation
Physical chemical treatment	Phase boundary potential  Adsorption Ion exchange Electrochemical reaction Super critical phase	Coagulation-settling Coagulation-flotation Activated carbon adsorption Ion exchange resin and membrane Electric Dialysis, Electrolysis Super critical water oxidation
Biological treatment	Aerobic decomposition  Anaerobic decomposition Anaerobic-aerobic reaction	Activated sludge process, Denitrification, Phosphorous removal Anaerobic digestion process Denitrification, Biological phosphorous removal

#### 1.2 Treatment Systems

Wastewater treatment systems are composed of unit operations in consideration of the wastewater properties, effluent quality level, cost performance, on-site environmental conditions, and the environment policy of the business. The conceptual relation between the treatment technologies and the treatment requirements in food processing factories are

schematically shown in Figure 2-1-1. As shown clearly in the figure, the major process used for treating wastewater is biological. In the pre-treatment stage, a screen is often used to remove floating materials such as labels and plastic sheets. A gravity oil separator is provided for oil containing wastewater generated by edible oil production. After the pre-treatment stage, normal level BOD is decomposed by an aerobic biological treatment, while high level BOD of several thousands to tens of thousands is diluted prior to treatment. In recent years this high level BOD wastewater tends to be treated, without dilution, by an anaerobic biological process in the pre-treatment stage, and then re-treated by an aerobic biological process. Introducing an anaerobic biological process benefits by reducing the load for the later stage aerobic biological process, converting organic materials in wastewater into fuel gas, downsizing the settling tank because of not using diluting water, and preventing sludge bulking. The BOD removal rate in the anaerobic biological process is normally between 80 and 90%. Then, the remaining BOD is removed by the aerobic biological process, which has a removal rate in the 95 to 99% range. When a factory is located in a sewer-serviced area, anaerobically pre-treated wastewater can be discharged directly to the sewer. When the factory's location is in a non-serviced area and the effluent quality is regulated strictly, then a tertiary treatment is required to reduce BOD, COD, SS. In such cases, sand filtration, coagulation-flocculation-sedimentation, and activated carbon absorption are, singly or in combination, added for the tertiary treatment. When nitrogen and phosphorous removal is required, biological de-nitrification and coagulation-flocculation-sedimentation are generally employed. Though a biological de-nitrification unit is sometimes used separately from the activated sludge process, a sequential combination of anoxic treatment and (aerobic) activated sludge process is normally used in order to reduce operating costs. The treatment processes for reusing water vary depending on the particular usage. For cooling and flush toilets, UF membrane filtration for the removal of fine particles is acceptable and RO membrane for desalinization for rinsing products will enable reuse. Now, disposal of excess sludge generated in wastewater treatment causes serious problems, economically and environmentally. Excess sludge has been mainly coagulated, dewatered, and compacted to form cake-like solids, which are then dumped for landfill in industrial waste dumpsites. When the excess sludge volume is large, the compacted cake is incinerated to reduce volume, and the ash is disposed of as mentioned above. Sometimes, sludge is composted or dried for fertilizer. Presently, treatment and disposal of sludge account for about 70% of the total operating cost in wastewater treatment plants, and the ratio is still

rising due to the lack of landfill sites. This has resulted in the popularization in recent years of new technologies using thermophilic bacteria enzymes, ozone oxidation, and mechanical forces to destroy microbial cells to reduce the sludge volume. They look very agreeable for fulfilling ISO 14000, the standards for global environmental management.

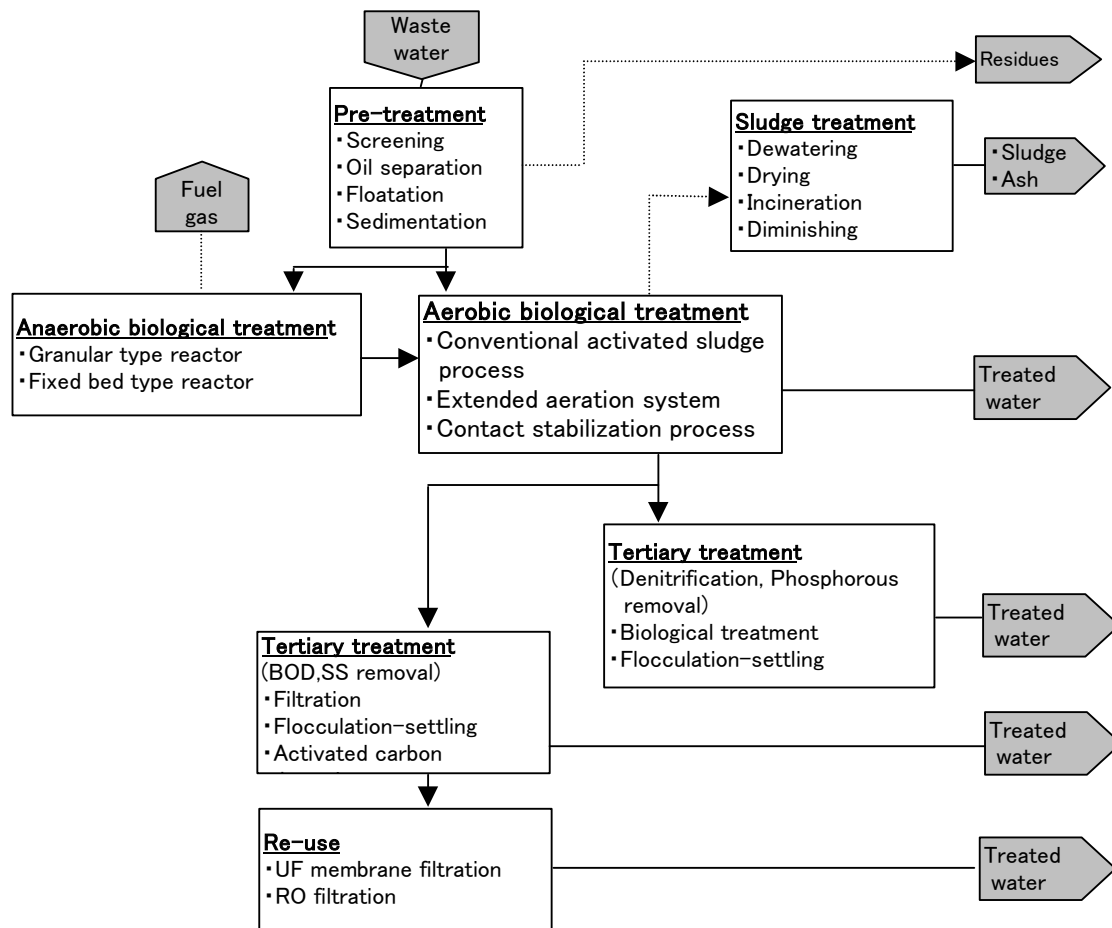

Figure 2-1-1 Typical wastewater treatment system

## Chapter 2 Basics of Wastewater Treatment and Facilities Design

### 2.1 Purpose and Goal of Wastewater Treatment

The purpose of wastewater treatment is one of the following:

1. to purify wastewater to the permissible level of the effluent standards
2. to treat wastewater to the allowable quality level for reuse

The effluent quality target is determined based on the allowances for unforeseeable fluctuations in effluent quality, wastewater volume increases due to future expansion plans and



probable changes in the surrounding conditions in addition to the existing official standards. Predicting the changes in effluent quality and volume, and surrounding conditions, however, including water shortages as well as the tightening of the regulatory control effluent quality and volume is extremely difficult. Therefore, designing a wastewater treatment plant on the basis of overestimated factors and uncertainty is obviously unrealistic. Consequently, designing based on cost performance is the most realistic and practical because the wastewater treatment capacity is an important factor for production capacity. If pre-treated effluent is discharged into a nearby sewer, the water quality standards and the service charges differ by locality. Therefore, the total pre-treatment costs and service charges shall be minimized for deciding the effluent quality. If the effluent is reused, the pre-treatment level varies depending on the usage. The quality is shown in Table 2-2-1.

Table 2-2-1 Standard quality of industrial water

Item	Standards concentration
Turbidity	20mg/?
pH	6. 5~8. 0
Alkalinity (CaCO <sub>3</sub> )	75mg/?
Hardness (CaCO <sub>3</sub> )	120mg/?
蒸発残留物	250mg/?
Chlorine ion (Cl <sup>-</sup> )	80mg/?
Iron (Fe)	0. 3mg/?
Manganese (Mn)	0. 2mg/?

## 2.2 Survey of Wastewater and Evaluation of Treatment Process

Prior to planning a wastewater treatment facility, the following surveys are conducted in similar factories in general.

### 1. Survey of Production Process and Wastewater

Usually wastewater is generated at each step in a series of production processes, and the mixture of different quality wastewaters flows to the wastewater treatment plant. The volume, quality, and hourly fluctuation of each individual wastewater and the mixed wastewaters are surveyed. If the products' quantity varies daily or seasonally, the fluctuation must also be surveyed. The water quality analysis shall cover the items specified by the rules plus the measured data for items such as chlorine concentration, temperature, TOD, TOC, total dry residues, which are needed for the treatment process design. Evaluation of the treatment

process is the next step after the survey. The evaluation examines reducing the wastewater volume and pollutants, leveling the fluctuation range, technical feasibility and economical viability of recovering useful materials, and the viability of reusing the treated water for reuse and quality requirements. Although the wastewater from food processing factories usually does not contain toxic and hazardous substances, the outlet flow of treated wastewater shall be managed strictly when it contains chlorine disinfectants used for sterilizing the production line equipment.

## 2. Survey of Surrounding Environment

Local conditions surrounding a factory such as the effluent standards, environmental conditions of the discharge point, administrative policies shall be studied carefully and clearly understood. Specified facilities and their layouts in relation with the wastewater treatment, methods of collecting wastewater from different sources, methods of discharging effluents, and the wastewater treatment plant site conditions are also surveyed. In addition, effluent quality standards for sewage water and the sewer service charge as well as the existence of community treatment facilities in industrial areas shall be examined too.

## 3. Treatability Test

When a factory has no wastewater treatment records or a new process and equipment are introduced, then a test shall be carried out for confirming the performance and collecting data necessary for the design. Two different types of testing are conceivable. The first, the pilot scale test, uses small-scale testing plants similar to the planned installation in the process sequence and in the operation. Therefore, it can collect data for fluctuating load conditions and study the performance. The second type, the batch test, tests each step of a serial process. Although it is discontinuous, the performance can be predicted reasonably, and the design data can be obtained. Regarding testing food processing wastewater, the load fluctuation often being wide and the wastewater being easily decomposable can be considered.

## 4. Comprehensive Evaluation

After surveying the production process, wastewater quality requirements, and surrounding conditions as well as comparatively studying a number of candidate processes, the most economic treatment process is selected. Generally, the construction and

operation/maintenance costs of separately treating wastewaters from different sources are estimated, and they are compared to the cost estimate for treating the mixture of wastewaters from all the sources together. The treatment processes and systems are evaluated based on economic comparisons. As the number of public sewer services for municipalities increase, more and more factories benefit from it in that industrial wastewater is received and treated by the services. The wastewater treatment facilities for discharging the effluent are called Pretreatment Facilities. As the cost performance of pretreatment facilities is affected by the effluent quality and service charges, those facilities' specifications are decided by considering the cost effectiveness. The relation of the effluent quality and the service charges is explained in Section 2-2 of Part 2. An industrial wastewater system, a similar service of collecting and treating industrial wastewater from factories, is sometimes provided in an industrial complex. If so, the most appropriate treatment process is decided similarly with public sewer services. In recent years, there is increasing public awareness that more consideration should be given to the environment in addition to the economic aspects described here. That means the selection of treatment processes and equipment is based on evaluating the life cycle costs, which include investment costs (depreciation, taxes and other public charges, insurance), operation costs (utilities consumption, disposal of by-products, credit for methane, etc.), maintenance costs (personnel costs, repair, etc.), and dismantling costs after the facilities service life. Under these social conditions, the waste minimization technologies, which recover the useful materials, in wastewater are considered effective for creating a resource recycling-oriented society.

### **2.3 Design Considerations**

In the design stage of a wastewater treatment plant, considering the economy, reliability, and safety of the plant, as well as the environment, is important, together with securing the performance of the plant. Stable processing to meet the load variations and water quality fluctuations is also important. Determining the capacity of each unit based on the momentary maximum peak load is economically inefficient. As a normal practice, a regulative tank process is installed which receives the inflow of varying rates and quality, and then equalizes it by storing and discharging the outflow at a constant rate and quality for treatment. As stoppage of wastewater treatment due to malfunctioning and accidents leads to suspending production, both production and treatment demand equally high reliability. Using expensive equipment just for reliability, however, is to be avoided, and a plant that can minimize some

capabilities without interrupting operation should be designed. For safety, a proactive protection system that monitors the process parameters (reaction, agitation, pH, temperature, pressure, etc.) provides warnings when it detects deviations from the predefined conditions and analyzes the root causes.

### **Chapter 3 Conformity with Effluent Standards**

The disputes on damages to fisheries caused by wastewater from paper mills in 1958 lead to legislation for industrial wastewater control and preserving the quality of public bodies of water. In December of the same year, the Water Quality Conservation and the Control of Effluent Emissions from Factories were legislated and they were enacted in March the following year. It turned out, however, that under the industry-oriented economic policies, no further industrial expansion was expected unless environmental issues were addressed. Then, in 1970, the two laws were unified to form the new Water Pollution Control Law. Under it, local governments were authorized to impose stricter regulations for limited water bodies that were not preserved sufficiently by the law.

#### **3.1 Considerations on Environment Quality Standards**

When a wastewater treatment plant is planned, harmonized co-existence of the local community and the industries should be considered, and Environment Quality Standards (EQS) should be clearly provided. Under the Basic Environment Law, EQS for water qualities are provided for protecting human health and conserving the living environment. The EQS for protecting human health stipulate 26 items of heavy metals, organic chlorine compounds, agro-chemicals, etc. They also stipulates 9 items for conserving the living environment, which are the pH, dissolved oxygen, suspended solids, biological oxygen demand, chemical oxygen demand, total phosphorus, total nitrogen, etc. The former 26 items are uniform national standards applicable to all public waters, while the latter 9 items are applicable to individual rivers, lakes, and coastal waters. The standards for protecting human health are shown in Table 2-3-1, and the standards for conserving living standards applied to rivers, lakes, and coastal waters are shown in Tables 2-3-2, 2-3-3, and 2-3-4.

Table 2-3-1 EQS for the protection of human health

Item	Standard values
Cadmium	0.01 mg/l or less
Total cyanide	Not detectable
Lead	0.01 mg/l or less
Chromium (VI)	0.05 mg/l or less
Arsenic	0.01 mg/l or less
Total mercury	0.0005 mg/l or less
Alkyl mercury	Not detectable
PCBs	Not detectable
Dichloromethane	0.02 mg/l or less
Carbon tetrachloride	0.002 mg/l or less
1,2-Dichloroethane	0.004 mg/l or less
1,1-Dichloroethylene	0.02 mg/l or less
cis-1,2-Dichloroethylene	0.04 mg/l or less
1,1,1-Trichloroethane	1.0 mg/l or less
1,1,2-Trichloroethane	0.006 mg/l or less
Trichloroethylene	0.03 mg/l or less
Tetrachloroethylene	0.01 mg/l or less
1,3-Dichloropropene	0.002 mg/l or less
Thiuram	0.006 mg/l or less
Simazine	0.03 mg/l or less
Thiobencarb	0.02 mg/l or less
Benzene	0.01 mg/l or less
Selenium	0.01 mg/l or less
N-nitrate and nitrite	10 mg/l or less
Fluorine	0.8 mg/l or less
Boron	1 mg/l or less

Table 2-3-2 EQS for conservation of the living environment

**Rivers** (except lakes and ponds)

Class	Purpose of water use	Standard values				
		pH	BOD	SS	DO	Total coliform
AA	Water supply class 1, conservation of natural environment, and uses listed in A-E	6.5-8.5	1 mg/? or less	25 mg/? or less	7.5 mg/? or less	50 MPN/100m? or less
A	Water supply class 2, fishery class 1, bathing and uses listed in B-E	6.5-8.5	2 mg/? or less	25 mg/? or less	7.5 mg/? or less	1000 MPN/100m? or less
B	Water supply class 3, fishery class 2, and uses listed in C-E	6.5-8.5	3 mg/? or less	25 mg/? or less	5 mg/? or less	5000 MPN/100m? or less
C	Fishery class 3, Industrial water class 1, and uses listed in D-E	6.5-8.5	5 mg/? or less	50 mg/? or less	5 mg/? or less	—
D	Industrial water class 2, agriculture water, and uses listed in E	6.0-8.5	8 mg/? or less	100 mg/? or less	2 mg/? or less	—
E	Industrial water class 3, and conservation of environment	6.0-8.5	10 mg/? or less	Floating matter such as garbage should not be observed	2 mg/? or less	—

(1) Standard figures are daily averages. (these apply correspondingly to lakes and coastal waters)

(2) At intake for agriculture, pH shall be between 6.0 and 7.5 and DO shall be more than 5 mg/?. (these apply correspondingly to lakes)

- (3) Conservation of natural environment: conservations of natural sight-seeing, etc.
- Water supply class 1 : simple water purification by filtration, etc.
  - Water supply class 2 : normal water purification by settling-filtration, etc.
  - Water supply class 3 : advanced water purification including pre-treatments, etc.
  - Fishery class 1 : for fishery biology in the oligosaprobic water areas (such as Yamame (*Oncorhynchus masou*), Japanese char (*Salvalinus pluv* and for fisherybiology of fishery class 2 and 3
  - Fishery class 2 : for fishery biology in the oligosaprobic water areas (such as salmon families and sweetish, etc.) for fishery biology of fishery class 3
  - Fishery class 3 : for fishery biology in the  $\beta$ -messaprobic water areas (such as carp, crucian, etc.)
  - Industrial water class 1 : normal water purification by sedimentation, etc.
  - Industrial water class 2 : advanced water purification by chemical dosing, etc.
  - Industrial water class 3 : specified water purification
  - Conservation of environment : at water qualities which do not give an unpleasant for people in the normal daily life (including a walk shore)

Table 2-3-3 Lakes

(natural lakes and reservoirs that have 10 million cubic meters of water or more)

Class	Purpose of water use	Standard values				
		pH	BOD	SS	DO	Total coli form
AA	Water supply class 1, fishery class 1, conservation of natural environment, and uses listed in A-C	6.5-8.5	1 mg/l or less	1 mg/l or less	7.5 mg/l or less	50 MPN/100m <sub>l</sub> or less
A	Water supply class 2 and 3, fishery class 2, bathing and uses listed in B-C	6.5-8.5	3 mg/l or less	5 mg/l or less	7.5 mg/l or less	1000 MPN/100m <sub>l</sub> or less
B	Water supply class 3, Industrial water class 1, agriculture water, and uses listed in C	6.5-8.5	5 mg/l or less	15 mg/l or less	5 mg/l or less	—
C	Industrial water class 2, and conservation of environment	6.0-8.5	8 mg/l or less	Floating matter such as garbage should not be observed	2 mg/l or less	—

1. Conservation of natural environment : conservations of natural sight-seeing, etc.
2. Water supply class 1 : simple water purification by filtration, etc.  
Water supply class 2 and 3 : normal water purification by settling-filtration, etc. or advanced water purification including pre-treatments, etc.
3. Fishery class 1 : for fishery biology in the oligotrophic water areas (such as Kokanee salmon) and for fishery biology of fishery class 2 and 3  
Fishery class 2 : for fishery biology in the oligotrophic lakes (such as salmon families and sweetish, etc.) for fishery biology of fishery class 3  
Fishery class 3 : for fishery biology in the eutrophic lakes (such as carp, crucian, etc.)
4. Industrial water class 1 : normal water purification by sedimentation, etc.  
Industrial water class 2 : advanced water purification by chemical dosing or specified water purification
5. Conservation of environment : at water qualities which do not give an unpleasant for people in the normal daily life (including a walk shore)

Class	Item Water use	Standard value (mg/l)	
		Total nitrogen	Total phosphorous
I	Conservation of natural environment and uses listed in II - V	<0.1	<0.005
II	Water supply classes 1,2, and 3 (except special types), fishery classes 1, bathing, and uses listed in III - V	<0.2	<0.01
III	Water supply classes 3 (special types), and uses listed in IV - V	<0.4	<0.03
IV	Fishery class 2 and uses listed in V	<0.6	<0.05
V	Fishery class 3, industrial water, agriculture water, and Conservation of the environment	<1	<0.1

1. Conservation of natural environment : conservations of natural sight-seeing, etc.
2. Water supply class 1 : simple water purification by filtration, etc.  
Water supply class 2 : normal water purification by settling-filtration, etc.  
Water supply class 3 : advanced water purification including pre-treatments, etc.
3. Fishery class 1 : for fishery biology in the oligotrophic water areas (such as salmon families and sweetish, etc.) for fishery biology of fishery class 2 and 3  
Fishery class 2 : for fishery biology such as pond smelt, etc and for fishery biology of fishery class 3  
Fishery class 3 : for fishery biology such as carp, crucian, etc.
4. Conservation of the environment : at water qualities which do not give an unpleasant for people in the normal daily life (including a walk shore)

Table 2-3-4 Coastal waters

**A**

Class	Purpose of water use	Standard values				
		pH	COD	DO	Total coli form	N-hexane extracts (oil, etc.)
A	Fishery class 1, bathing conservation of natural environment, and uses listed in B-C	7.8-8.3	2 mg/ℓ or less	7.5 mg/ℓ or less	1000 MPN/100mℓ or less	ND
B	Fishery class 2, industrial water and uses listed in C	7.8-8.3	3 mg/ℓ or less	5 mg/ℓ or less	—	ND
C	Conservation of environment	7.8-8.3	8 mg/ℓ or less	2 mg/ℓ or less	—	—

- 1. Conservation of natural environment : conservations of natural sight-seeing, etc.
- 2. Fishery class 1 : for fishery biology such as red sea bream, yellowtail, wakame seaw etc. and for fishery biology of fishery class 2
- Fishery class 2 : for fishery biology of striped mullet, laver, etc
- 3. Conservation of environment : at water qualities which do not give an unpleasant for people in the normal daily life (including a walk shore)

**B**

Class	Water use	Standard value (mg/ℓ)	
		Total nitrogen	Total phosphorous
I	Conservation of natural environment and uses listed in II – IV(except fishery classes 2 and 3)	<0. 2	<0. 02
II	Fisher class 1, bathing, and the uses listed in III – IV(except fishery classes 2 and 3)	<0. 3	<0. 03
III	Fishery class 2 and the uses listed in IV (except fishery classes 3)	<0. 6	<0. 05
IV	Fishery class 3, industrial water, and conservation of habitable environment for marine biota	<1	<0. 09

- 1. Conservation of natural environment : conservations of natural sight-seeing, etc.
- 2. Fishery class 1 : well kept balance in various fishery biota including benthic shell and fish and stable fishing
- Fishery class 2 : big catching of fishery biota, mainly fish, except some part of benthic shell and fish
- Fishery class 3 : catching of specified fishery biota which are strong to pollutions
- 3. Conservation of habitable : habitable critical conditions for benthic biota throughout the year



### 3.2 Effluent Standards

The Water Pollution Control Law is designed to protect Public Water Areas and groundwater from industrial wastewater contamination in order to protect human health and preserve living standards. The law establishes uniform national standards and authorizes local governments to legislate ordinances for stricter enforcement of the effluent standards of wastewater discharged to Public Water Areas from factories. The ordinances are applied to specified facilities which discharge wastewater if they meet one of the following conditions set by Cabinet Order:

1. The wastewater contains cadmium and other substances designated by Cabinet Order that could harm human health.
2. The wastewater indicates a pollution level that could harm living environments with the items designated by Cabinet Order including those caused by thermal effect and COD, in addition to the items specified in 1 above.

Two types of effluent standards, one for protecting human health and one for preserving living standards, are established. As of 1996, the Water Pollution Control Law was applied to about 30,000 businesses discharging wastewater. The national effluent standards are uniformly applied throughout Japan and consist of two categories, one for protecting human health and the other for preserving living standards. The standards for human health specify the 27 items shown in Table 2-3-5, and those for living standards specify the 15 items shown in Table 2-3-6. As shown in Table 2-3-7, the Water Pollution Control Law establishes 3 kinds of effluent standards in addition to the uniform national standards in order for effluent control to be managed effectively for industries, localities, business sizes, and regulations. If a prefectural governor decides that the national effluent standards are insufficient, the governor is authorized to enforce more stringent controls for specific water areas by setting higher level effluent qualities than the national standards or by lowering the effluent volume threshold to include businesses discharging less than 50 m<sup>3</sup>/day. In general, the achievement ratio for the effluent quality standards (COD) is low in enclosed water bodies when compared to other areas, mainly because nutrient salts containing nitrogen and phosphorus constantly flow in, promoting eutrophication. In these enclosed water bodies, red tides frequently break out. The Total Pollution Load Control was set within the framework of the Water Pollution Control Law, and the control has been applied to some areas in order to improve the water quality in those

areas polluted by surrounding industrial zones. In areas such as the Tokyo Bay, Ise Bay, and Inland Sea, the effluent from the specified facilities has been strictly controlled. The achievement rates for the COD reduction goals were reported, and new goals have been set every 5 years. The 5th Total Pollution Load Control starting in 2002 aims at more effectively reducing nitrogen and phosphorus as well as COD. To control specific water areas, local governments can add items not specified in the national standards and/or supervise wastewater-discharging plants that are not designated as specified facilities by national standards.

Table 2-3-5 Items related to the protection of human health  
(Uniform National Effluent Standards)

Toxic substances	Permissible limits
Cadmium and its compound	0.1 mg/ℓ as cadmium
Cyanide compounds	1 mg/ℓ as cyanide
Organic phosphorous compounds (limited to paration, methyl paration, EPN)	1 mg/ℓ
Lead and its compounds	0.1 mg/ℓ as lead
Chromium (VI)	0.5 mg/ℓ
Arsenic and its compounds	0.1 mg/ℓ as arsenic
Total mercury	0.005 mg/ℓ as mercury
Alkyl mercury compounds	Not detectable
PCBs	0.003 mg/ℓ
Trichloroethylene	0.3 mg/ℓ
Tetrachloroethylene	0.1 mg/ℓ
Dichloromethane	0.2 mg/ℓ
Carbon tetrachloride	0.02 mg/ℓ
1,2-Dichloroethane	0.04 mg/ℓ
1,1-Dichloroethylene	0.2 mg/ℓ
cis-1,2-Dichloroethylene	0.4 mg/ℓ
1,1,1-Trichloroethylene	3.0 mg/ℓ
1,1,2-Trichloroethane	0.06 mg/ℓ
1,3-Dichloropropene	0.02 mg/ℓ
Thiuram	0.06 mg/ℓ
Simazine	0.03 mg/ℓ
Thiobencarb	0.2 mg/ℓ
Benzene	0.1 mg/ℓ
Selenium and its compound	0.1 mg/ℓ as selenium
Boron and its compound	10 mg/ℓ as boron
Fluorine and its compound	8 mg/ℓ as fluorine
Ammonia, ammonia compounds, N-nitrite and N-nitrate	100 mg/ℓ※

※ (N-ammonia, ammonia compounds) x 0.4 + N - nitrite + N-nitrate

Table 2-3-6 Items related to the protection of the living environment

(Uniform National Effluent Standards)

Living environment items	Permissible limits
pH discharge to non-marine	5.8~8.6
discharge to marine	5.0~9.0
BOD	160 mg/ℓ (daily average 120 mg/ℓ)
COD <sub>Mn</sub>	160 mg/ℓ (daily average 120 mg/ℓ)
SS	200 mg/ℓ (daily average 150 mg/ℓ)
N-hexane extracts mineral oils	5 mg/ℓ
animal and vegetable oils	30 mg/ℓ
Phenols	5 mg/ℓ
Copper	3 mg/ℓ
Zinc	5 mg/ℓ
Dissolved iron	10 mg/ℓ
Dissolved manganese	10 mg/ℓ
Chromium	2 mg/ℓ
Fluorine	15 mg/ℓ
Number of coli form groups	daily average 3 000/cm <sup>3</sup>
Nitrogen	120 mg/ℓ (daily average 60 mg/ℓ)
Phosphorous	16 mg/ℓ (daily average 8 mg/ℓ)

Table 2-3-7 Regulated standards for the enforcement of water pollution control

Standards and applied businesses	Applied area	Applied facilities scales	Regulated items
Uniform National Effluent Standards for all business	public water area throughout the country	Specified Facilities specified in the law	*the living standards items *harmful materials
Prefectural Stringent Effluent Standards	areas where are required more stringent effluent standards to achieve environmental standards and are regulated by prefectural ordinance in accordance with the Water Pollution Control Law	Specified Facilities specified in the law (sometime extended to businesses of less than 50 m <sup>3</sup> /d of effluent)	*the living standards items *harmful materials
Area Wide Total Pollutants Control	specified water area specified by law (Tokyo Bay, Ise Bay and Seto Inland Sea)	Specified Facilities specified in the law	*specified materials (COD, N, P)
Prefectural specified effluent regulation for specified business	areas where are required more stringent effluent standards to achieve environmental standards and conservation of waters regulated by prefectural ordinance	Specified Facilities specified in the law and facilities other than these facilities	*items not specified current effluent standards

### 3.3 Discharge to Sewers

Under the Sewage Law, the specified facilities and the industries, which intend to discharge wastewater of certain volume and quality meeting the conditions shown in Table 2-3-8, are required to report to the responsible agency. *Discharging to sewer* and *acceptable effluent quality criteria* are referred to as Sewerage Collection and Sewerage Collection Standards. Based on the Water Pollution Control Law and the Law Concerning Dioxins, local governments are authorized to establish ordinances on Sewerage Collection Standards, considering the local environmental conditions. The Sewerage Collection Standards stipulate items which could harm human health (Table 2-3-9), items which could damage the living environment (Table 2-3-10), items which could overload sewage treatment (Table 2-3-11), and items which could damage sewer facilities (Table 2-3-12). These tables are examples from Kobe. Biological oxygen demand (BOD), suspended solids (SS), and animal/plant fat/oil are accepted by paying additional charges, however, because they are treatable in the sewage treatment plant. In Kobe, those who meet the following two conditions are allowed to discharge higher concentration wastewater than the Sewerage Collection Standards stipulate if they pay additional charges.

Table 2-3-8 Items imposed duty of reporting for the usage of sewerage

Pertinent items	Pertinent wastewater volume and qualities
Wastewater volume (daily maximum)	>50m <sup>3</sup>
Pertinent effluent qualities	
pH	<5.7 or >8.7
BOD	>300 mg/l
SS	>300 mg/l
Animal and vegetable oils	>300 mg/l
Temperature	>°C40
N-ammonia N-nitrite N-nitrate	>300 mg/l
Nitrogen compounds	>300 mg/l
Phosphorous compounds	>300 mg/l
others	not fulfill the permisble levels in Table 2-3-9~12

Table 2-3-9 Items related to the protection of human health

Dioxins (Kobe city)	
Items	Permissible limits
Dioxins	<10pg-TEQ/l

Other than dioxins (Kobe city)		
Items	Permissible limits (< mg/l)	
	Service area of sewage treatment plant	
	Higashinada, Chuo, Tarumi	Port Island
Cadmium and its compound	0.05 mg/l	0.03 mg/l
Cyanide compounds	0.7 mg/l	0.3 mg/l
Organic phosphorous compounds	0.7 mg/l	0.3 mg/l
Lead and its compounds	0.1 mg/l	0.1 mg/l
Chromium (VI)	0.35 mg/l	0.1 mg/l
Arsenic and its compounds	0.1 mg/l	0.05 mg/l
Mercury, alkyl mercury and mercury compounds	0.005 mg/l	0.005 mg/l
Alkyl mercury compounds	Not detectable	Not detectable
PCBs	0.003 mg/l	0.003 mg/l
Dichloromethane	0.2 mg/l	0.2 mg/l
Carbon tetrachloride	0.02 mg/l	0.02 mg/l
1,2-Dichloroethane	0.04 mg/l	0.04 mg/l
1,1-Dichloroethylene	0.2 mg/l	0.2 mg/l
cis-1,2-Dichloroethylene	0.4 mg/l	0.4 mg/l
1,1,1-Trichloroethane	3.0 mg/l	3.0 mg/l
1,1,2-Trichloroethane	0.06 mg/l	0.06 mg/l
Trichloroethylene	0.3 mg/l	0.3 mg/l
Tetrachloroethylene	0.1 mg/l	0.1 mg/l
1,3-Dichloropropene	0.02 mg/l	0.02 mg/l
Thiuram	0.06 mg/l	0.06 mg/l
Simazine	0.03 mg/l	0.03 mg/l
Thiobencarb	0.2 mg/l	0.2 mg/l
Benzene	0.1 mg/l	0.1 mg/l
Selenium and its compound	0.1 mg/l	0.1 mg/l
Boron and its compound	230 mg/l	230 mg/l
Fluorine and its compound	15 mg/l	15 mg/l

Table 2-3-10 Items related to the protection of the living environment (Kobe city)

Items	Permissible limits
Phenols	<5 mg/l
Copper and its compounds	<3 mg/l
Zinc and its compounds	<5 mg/l
Iron and its compounds (dissolved)	<10 mg/l
Manganese and its compounds (dissolved)	<10 mg/l
Chromium and its compounds	<2 mg/l

Table 2-3-11 Loading items to sewage treatment plant (Kobe city)

Items	Permissible limits
pH	≥5 or <9
BOD <sup>※</sup>	<2000 mg/l
SS <sup>※</sup>	<2000 mg/l
N-hexane extracts animal and vegetable oils	<150 mg/l
mineral oils	<5 mg/l

Remarks: <sup>※</sup>not applied to the businesses discharging less than 50 m<sup>3</sup>/ month of wastewater volume

Table 2-3-12 Items which may damage the sewage treatment facilities (Kobe city)

Items	Permissible limits
Temperature	<45°C
Iodine consumption	<220 mg/l

1. Effluent volume; monthly discharge volume exceeds 500 m<sup>3</sup>
2. Effluent quality; biological oxygen demand (BOD) 200 mg/ℓ~2,000 mg/ℓ
  - suspended solids (SS) 200 mg/ℓ~2,000 mg/ℓ
  - animal/plant fat/oil 30 mg/ℓ~150 mg/ℓ

The additional charges are calculated in the following two steps:

Computation of F:

$$F \text{ (concentration of effluent)} = A + 1.1 \times B + 2 \times C$$

where

A: Effluent BOD – 200, when the BOD exceeds 200 mg/ℓ

B: Effluent SS – 200, when the SS exceeds 200 mg/ℓ, and

C: Effluent animal/plants fat/oil – 30, when the animal/plant fat/oil exceeds 30 mg/ℓ

Calculation of the additional charge:

Find a unit price corresponding to the value F from Table 2-3-13.

Multiply it by the effluent volume.

Table 2-3-13 Additional charges for effluent qualities (F)

effluent qualities (F)	Unit price ¥/ m <sup>3</sup>
1 ~ 100	9
101 ~ 300	35
301 ~ 500	70
501 ~ 800	110
801 ~ 1,100	165
1,101 ~ 1,500	225
1,501 ~ 2,000	300
2,001 ~ 2,500	390
2,501 ~ 3,400	510

The total amount paid is the standard sewage fee plus the additional charge.

## Chapter 4 Pretreatment Technologies

### 4.1 Screening

#### 1. Basic Screening Technology

Screening is a technology to remove relatively large floating matter by passing

wastewater through screens and trapping the matter on the screens. Each screen is generally installed in the wastewater channel or at a wastewater storage tank inlet so that wastewater flows through it due to gravity. Trapped matter reduces the flow rate by friction loss and raises the upstream water level if the matter is left on the screens. Therefore, the matter must be raked up occasionally. Raking is done mechanically or manually. A bar screen, vibration screen, or rotating drum is often used. The bar screen is the most popular because of its easy installation, easy maintenance, reasonable cost, and other attractive features.

#### A. Effective Screen Openings

Screens made of flat steel bars are divided into the following three types, which are coarse screens with grid spacing greater than 150 mm, normal screens with grid spacing between 15~50 mm, and fine screens with grid spacing less than 15 mm. A coarse screen, which is set upstream of a normal screen, is used to protect it. The normal screen is most widely used to protect mechanical equipment at wastewater treatment facilities. The fine screen is mainly installed to remove fine materials that adversely affect the microbial processes.

#### B. Guidelines for Bar Screens

According to the design standards issued by the Japan Sewage Association, domestic wastewater screens are to be made of flat steel grids with effective spacing of 20~25 mm and provided with raking equipment. They are to be installed at a tilt angle of approximately 70 degrees, enabling a flow speed of 0.45/m velocity for the planned flow rate, and should be strong enough for 1.0 meter head loss before and behind. The influent of wastewater treatment contains relatively small amounts of floating materials because large materials in the wastewater are usually removed by screens in food processing factories. Therefore, the normal screen with hand raking is widely used, installed at a tilt angle of 40~60 degrees from a horizontal position. If the flow volume is small, and the volume of floating materials is large, then a rotating bar screen is preferred. Head loss (hr) at the bar screen is calculated by the following formula:

$$hr = \beta \sin \alpha (t/b)^{4/3} v^2$$

where,  $\alpha$ : screen tilt angles to a horizontal position

t: screen bar thickness

$\beta$ : coefficient due to screen bar shape

1.79 for circle rod bar

1.67 for flat bar with half circles in front and rear

2.42 for rectangular bar

b: effective screen bar spacing

v: flow velocity in front of screen

Actual total head loss is obtained by adding the friction loss caused by trapped matter to the loss calculated above. If these conditions are accounted for, the screen width is generally about 180% of the width of the upstream channel.

## 2. Screen Type

The bar screens with mechanical raking, hand raking, and rotating type raking are commonly used for treating wastewater in food processing factories, but a rotating drum micro screen covered with stainless filter mesh at about 200~1,000  $\mu$  effective spacing and a screen with a shredder are also used. The typical bar screen designed for hand raking and the rotating screen are shown in Figures 2-4-1 and 2-4-2.

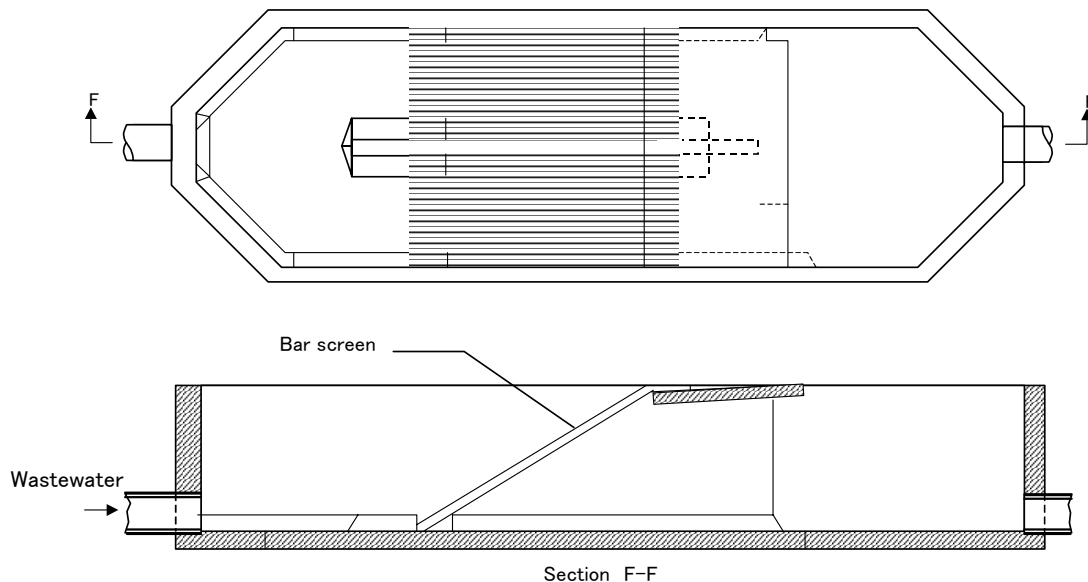

Figure 2-4-1 Bar screen



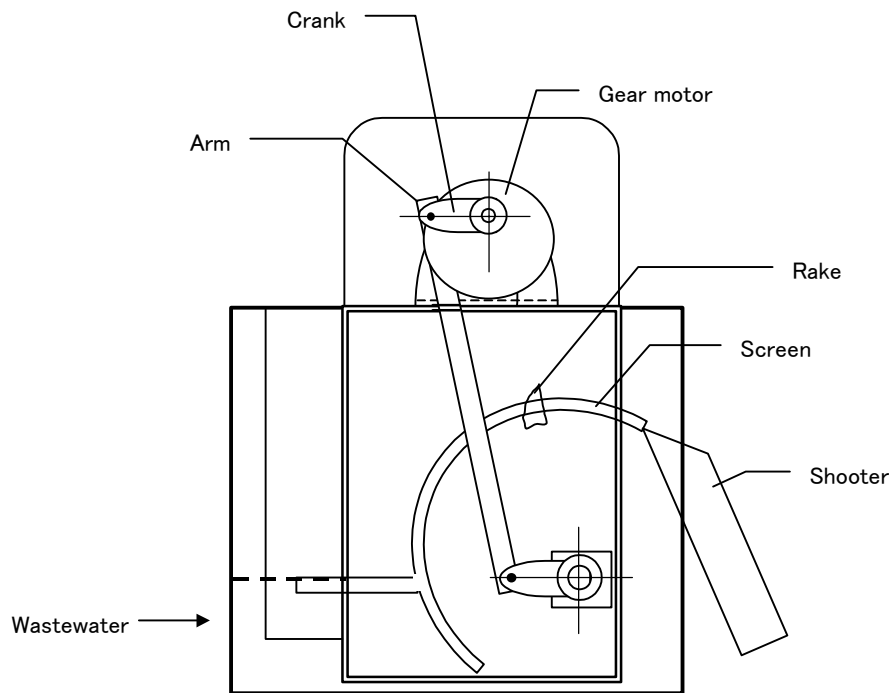

Figure 2-4-2 Rotary bar screen

## 4.2 Oil Separation<sup>1)</sup>

### 1. Basic Technology for Oil Separation

Usually oil in wastewater floats and is separated from the water by using the difference of the densities between oil and water. Stokes' law can be applied to determine the floating velocity of oil particles in water.

$$V_r = (g / 18 \mu) (P_w - P_o) D^2$$

where  $V_r$ : floating velocity of oil particles (cm/s)

$g$ : gravitational acceleration (cm/ s <sup>2</sup>)

$\mu$  : absolute viscosity of water (P)

$P_w$ : water density (g/cm<sup>3</sup>)

$P_o$ : oil density (g/cm<sup>3</sup>)

$D$ : diameter of oil particle (cm)

If uniform oil particles of 150  $\mu$  ( $D=0.015$  cm) in diameter are separated in a complete laminar flow,  $V_r$  is calculated as shown below:

$$V_r = (980 / 18 \times 0.01) \times (1.0 - 0.9) \times 0.015^2 = 0.12 \text{ cm / s}$$

Assuming that the horizontal velocity of wastewater  $V_H = 90 \text{ cm / min} = 1.5 \text{ cm / s}$  and the water depth  $d = 240 \text{ cm}$ , the time needed for the oil particles at point B in Figure 2-4-3 to reach the water surface is calculated as shown below:

$$t = d / V_r = 240 / 0.12 = 2,000 \text{ sec} = 33.2 \text{ min}$$

In the meantime, wastewater travels from A to B during time  $t$ . The distance  $L$  is calculated as shown below:

$$L = (V_H / V_r) d = V_H t = 1.5 \times 2,000 = 3,000 \text{ cm} = 30 \text{ m}$$

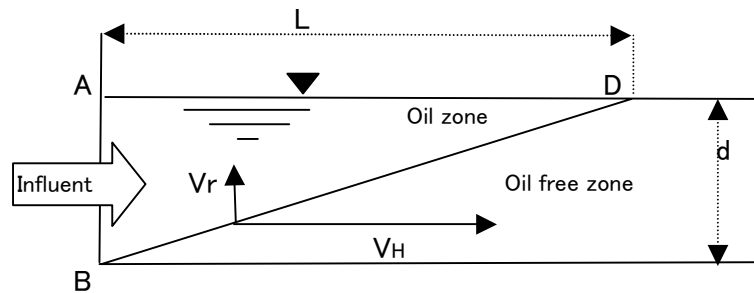

Figure 2-4-3

In this instance, oil particles of 0.015 cm in diameter exist only above the float-critical-line B-D and do not exist below B-D, where they are separated completely from the water. Still, the actual oil separation is not that effective because the complete laminar flow cannot be realized in the tank. The flow is affected by the wall surface and convection current due to temperature differences. The flow is also disturbed by the wind, and the flow drift is affected by the inside structure. According to the American Petroleum Institute (API) specifications widely used for industrial wastewater treatment, the total length of the oil separator is decided by multiplying the theoretical length by the turbulent flow coefficient ( $F_t = 1.07 \sim 1.45$ ) and the short circuit flow coefficient ( $F_s = 1.2$ ).

## 2. Types of Oil Separators

Typical oil separators are the API oil separator without any components inside the tank, the PPI (parallel plate interceptor) oil separator with parallel plates inside the tank, and

the CPI (corrugated plate interceptor) oil separator with corrugated plates inside the tank. As the oil contents in wastewater from food processing factories are generally low except for those from factories producing cooking oil, a full-rigged oil separator is not needed. Oils are generally removed together with grit and scum at the wastewater channel which functions simultaneously as a grit chamber and scum separator. If the oil contents are high, the oils are generally removed together with suspended solids by using floatation equipment.

### 4.3 Sedimentation

#### 1. Basic technology<sup>2)</sup>

The most important factors affecting the settling velocity of solid particles in liquid are the size and density of the particles and the viscosity and density of the liquid. Therefore, if the density of solid particles is equal to that of the liquid, no sedimentation occurs. If the density of particles and liquid differs, then gravity ( $F_g$ ) works on the particles in proportion to the difference between the particle mass and liquid mass which replace the particles as formulated below:

$$F_g = V(\rho_1 - \rho)g$$

where  $V$ : volume of a particle ( $\text{cm}^3$ )

$\rho_1$ : density of a particle ( $\text{cm}^3$ )

$\rho$ : liquid density ( $\text{g} / \text{cm}^3$ )

$g$ : gravitational acceleration ( $\text{cm} / \text{s}^2$ )

If inertia does not work on the liquid being pushed away by the settling particles, then the velocity that the particles settle at would be accelerated infinitely by gravity. The influence of the inertia force of the liquid increases in proportion to the increase in the settling velocity of the particles, and decelerates the movement of the particles. Newton shows that the drag force ( $F_D$ ) is due to inertia and is in proportion to the second power of velocity:

$$F_D = 1/2 \cdot C_D A \rho v^2$$

where  $A$ : particle's sectional area orthogonal to velocity vector

$C_D$ : drag coefficient.

$v$ : particle's settling velocity

When the upward drag force ( $F_D$ ) and the downward gravity force ( $F_g$ ) balance, the particle falls at a constant velocity.

$$V(\rho_1 - \rho)g = \frac{1}{2} \cdot C_D A \rho v^2$$

$$v = \left[ \frac{2V(\rho_1 - \rho)g}{C_D A \rho} \right]^{1/2}$$

When the particle is a sphere of  $D$  in diameter,

$$A = \frac{1}{4} \pi D^2 \quad \text{and} \quad V = \frac{1}{6} \pi D^3$$

Then the settling velocity is calculated as shown below:

$$v = \left[ \frac{4g(\rho_1 - \rho)D}{3C_D \rho} \right]^{1/2}$$

The drag coefficient ( $C_D$ ) varies largely depending on the particle shape. For same shaped particles it is a function of the Reynolds number ( $R$ ) as shown below:

$$R = vD/\nu = vD\rho/\mu$$

where  $\nu$  : coefficient of kinetic viscosity  
 $\mu$  : coefficient of viscosity

Stokes calculates the drag force ( $F_D$ ) for a small particle moving at a low velocity as below:

$$F_D = 3\pi\mu Dv$$

As the drag coefficient ( $C_D$ ) is equal to  $24/R$  under Stokes' law, the settling velocity is calculated as shown below:

$$v = \frac{g}{18\mu}(\rho_1 - \rho)D^2$$

This formula, which calculates a solid particle's settling velocity in liquid, is called Stokes' equation.

The actual sedimentation efficiency, however, is lower than the results theoretically calculated above because most particles are irregularly shaped instead of being spherical, the

complete laminar flow cannot be realized in the tank, the flow is affected by the wall surface and convection current due to temperature differences, the flow is disturbed by wind, and/or the flow drift is affected by the inside structure.

## 2. Settling Tank

There are two types of settling tanks, the circular tank shown in Figure 2-4-4 and the rectangular tank shown in Figure 2-4-5. The circular tank is most commonly used due to its economical construction cost. The depth of water is generally about 3 m regardless of the tank's treatment capacity. The required surface area of a settling tank is calculated based on the sludge blanket settling velocity or clarified water zone descending velocity. The surface overflow rate for ordinary organic sludge is  $0.5\sim 0.8 \text{ m}^3 / \text{m}^2 \cdot \text{hr}$ . The shapes and mechanisms of the sludge collector are similar for both circular and rectangular settling tanks, but the strengths of the inner structures and drive units are designed to accommodate light, middle, or heavy loads, taking account of the sludge characteristics shown in Table 2-4-1. In food processing wastewater treatment, the light load settling tank technology is applied to all of the primary settling tanks, the final settling tank for activated sludge, and the coagulation-settling tank for the post activated sludge process.

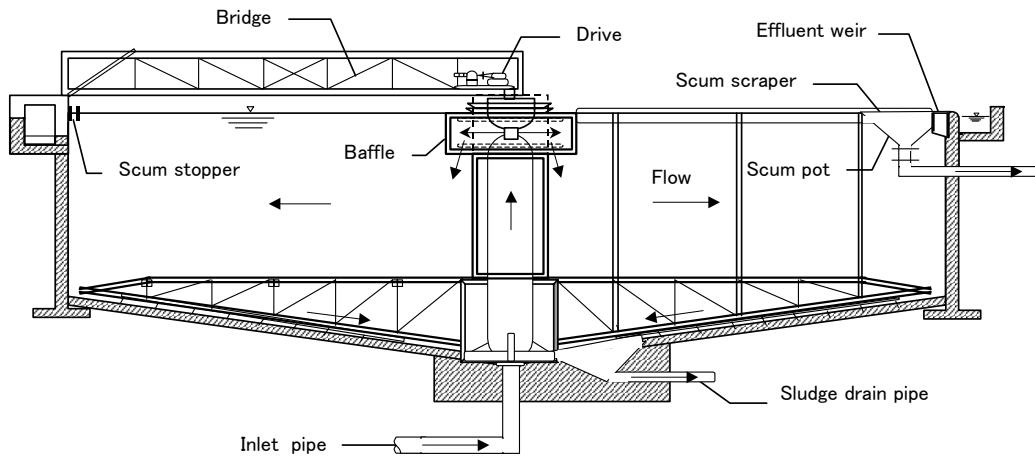

Figure 2-4-4 Circular settling tank

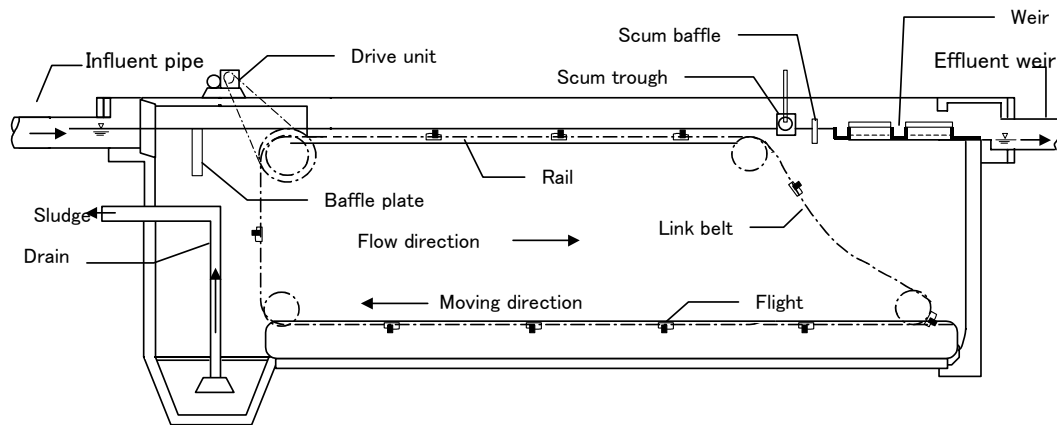

Figure 2-4-5 Rectangle settling tank

Table 2-4-1 Sludge characteristics and design load of sludge collector

Load	Light load	Middle load	Heavy load
Sludge characteristics	Light sludge such as organic sludge, aluminum hydroxide, etc.	Calcium sulfate, calcium carbonate, clay, etc	Heavy sludge such as sands, iron oxide, etc.
Apparent specific gravity	1.0~1.03	1.03~1.17	1.17~1.45
Draining sludge concentration (%)	<5	5~20	20~40

#### 4.4. Dissolved Air Flootation

##### 1. Basic technology

The dissolved air flotation (DFA) method involves water pressurized under 3~5 kg/cm<sup>2</sup> (0.29~0.49 MPa) and saturated with air. This water is poured into wastewater under atmospheric pressure. Then, clouds of fine bubbles of 70~80 μm diameter are generated. The bubbles either trap the solid particles by physical force or adhere to the solid particles by surface tension working on the three phases among solid particles, bubbles, and water in order to form agglomerated particles which, though heavier than water, rise to the surface. The surface tension among gas, liquid, and solid is generally considered to work on the three phases as shown in Figure 2-4-6, and the geometrical equilibrium state among the surface tensions is defined as:

$$\sigma_{GS} = \sigma_{SL} + \sigma_{GL} \cdot \cos \sigma$$

where  $\sigma_{GS}$ : surface tension between gas and solid  
 $\sigma_{SL}$ : surface tension between solid and liquid

$\sigma_{GL}$ : surface tension between gas and liquid

$\theta$ : contact angle

If contact angle ( $\theta$ ) is 0, the contact force is zero and the bubbles cannot adhere to the solids. If  $\sigma_{GS}$  is greater than  $\sigma_{SL}$ , contact angle ( $\theta$ ) is larger than 0 and bubbles tend to adhere to solids. When contact angle ( $\theta$ ) is 180°, the adhering force reaches the maximum. Sludge coagulation by PAC, polyelectrolyte, etc. is effective for accelerating the adhesion of bubbles to solids. In addition, there are two methods using interfacial tension adjustments. The first method is to lower  $\sigma_{GL}$  (surface tension between gas and liquid) by reducing the surface tension of water with frother. Surfactant, alcohols with 5~8 carbon, and saponins are generally used for this reaction. The surfactant shall be selected for stability, dispersibility, etc. along with frothing ability. The second method is to reduce  $\sigma_{SL}$  (surface tension between solid and liquid) or increase  $\sigma_{GS}$  (surface tension between gas and solid) with collectors. Chemicals capable of both frothing and collecting are mainly used although oil-base-collectors were used in the past.

## 2. Dissolved Air Flootation (DAF) Unit

Dissolved air floatation is intended to directly remove SS and oils that are not dissoluble in water. Soluble pollutants, which are indicated by COD, BOD, colors, etc., are removed by DAF after effective coagulation. A DAF unit can usually suitably treat SS ranging from 150 mg/l to 2,000 mg/l after coagulation, but DAF cannot be applied when the settling velocity of coagulated floc is lower than 20 m/h. The removal rates of BOD, COD, color, etc. shall be confirmed with a treatability test. A DAF unit dissolves air in pressurized water at 3~5 kg/cm<sup>2</sup>, then releases it at ambient pressure. Figure 2-4-7 shows the schematic flow. Two conditions should be met in order to calculate the circulation water volume. These conditions are that 1 kg SS (dry base) of influent requires 20 m<sup>3</sup> of dissolved air, and the ratio of dissolved air to circulation water is 4% in volume. In typical wastewater treatment for food processing, 30% of the influent is pressurized by a pump, and air is sucked in through an ejector in the circulation loop, which is fed in at the suction side of pump. There, the pump's impeller disperses air into the water and sends the water into the air dissolving tank. The water saturated with air is returned to the floatation tank to be released into the atmosphere where fine bubbles are formed and adhere to solids. These bubbles rise to the surface carrying the solids with them and are then collected by scrapers. The typical value of the collected sludge

concentration is 10,000~20,000 mg/l for ordinary food wastewater and 6,000~12,000 mg/l for coagulated oil.

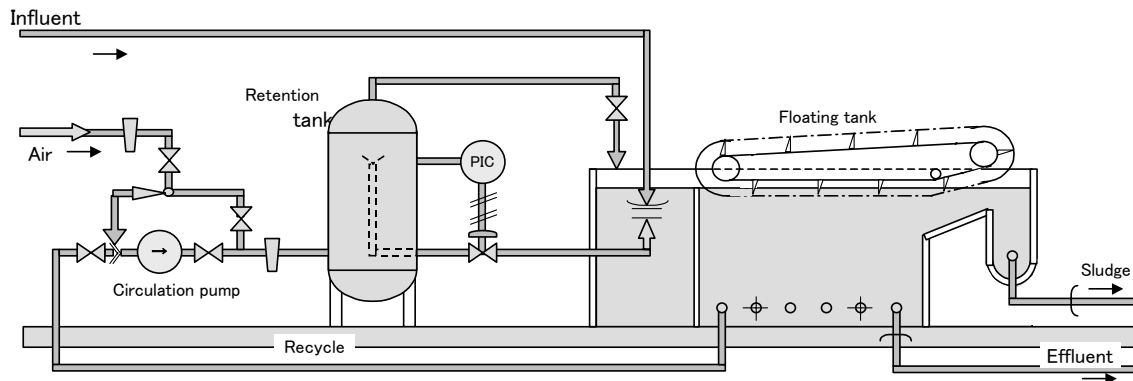

Figure 2-4-7 Dissolved air floatation

## 4.5 Coagulation

### 1. Basic Technology

Coagulation is widely used as a main unit operation in wastewater treatment. When fine particles causing turbidity and color in wastewater should be removed, they rarely settle by themselves due to their small size. When they are joined together to form larger particles, they settle more quickly. The operation for flocculation is called coagulation. The settling velocity increases in proportion to the second power of the diameter of particles as proved by Stokes' law. Coagulation is thought to occur by electric, chemical, and physical forces, working independently or in combination. Generally, suspended solids in water are positively or negatively charged. Similarly charged particles do not bond owing to Coulomb's repulsive force. The smaller the particle, the larger the surface area for the weight, and this results in stronger effects of electric charges on the particle surface. When the particle size decreases down to the colloidal level ( $10^{-4}$  -  $10^{-7}$ cm), the effect becomes so great that the particles are stably suspended for a long time. If chemicals with opposite electric charges are added to the water, the particle's electric charge decreases drastically or comes down to zero. This phenomena is electric neutralization which makes the particles come closer more easily and bond under van der Waals force.



## 2. Coagulants

### A. Coagulation by Electrolytes

Schulze's and Hardy's experiments proved that the coagulation of colloidal particles with electrolytes is made by bonding oppositely charged ions, and the bonding effect is greater for atoms of larger valence. The effect is greater for atoms of larger weight among equal valence.

The minimum concentration in which coagulation is caused by colloidal particles in a given time period is called the "coagulation value" of electrolyte. The proven order of coagulation values coagulating negatively-charged colloidal particles is as follows<sup>3)</sup>:

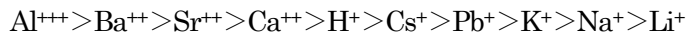

The order of coagulation values coagulating positively charged colloidal particles is also shown below:



### B. Coagulation by Hydrated Metal Oxides

As the surface of suspended particles in water is generally charged negatively, feeding a positively charged substance causes coagulation. Since hydroxides of Fe, Al, etc. or oxide hydrates are charged positively at around pH 7, these are used as coagulants. Aluminum hydroxide ( $\text{Al}(\text{OH})_3$ ) is formed by hydrolysis of aluminum sulfate ( $\text{Al}_2(\text{SO}_4)_3 \cdot 18\text{H}_2\text{O}$ ) in water. As floc of aluminum hydroxide ( $\text{Al}(\text{OH})_3$ ) has an extremely large porous surface, it effectively traps suspended matter by physical adsorption. Similarly  $\text{Fe}(\text{OH})_2$  or  $\text{Fe}(\text{OH})_3$  is formed by iron sulfate ( $\text{FeSO}_4 \cdot 7\text{H}_2\text{O}$ ) and iron chloride ( $\text{FeCl}_3$ ) in water. Compared with aluminum sulfate, they are cheaper and their hydroxide density is heavier. Therefore, they are preferred in wastewater treatment.

### C. Coagulation by surfactants

The substances that remarkably decrease the surface tension of liquids are called surfactants. Surfactants are characterized as anionic, cationic, nonionic, and polyampholite. They are adsorbed to oppositely-charged suspended particles, neutralize the electric charges, makes the particle surfaces hydrophobic, and then agglomerate each other. The surfactants have stronger coagulation force than inorganic coagulants, but they are very expensive.

#### D. Coagulation by Organic Macromolecular Compounds

Organic macromolecular compounds are acids or bases of polyelectrolyte synthesized by polymerization or condensation. They have stronger coagulation force than surfactants. When dissolved, polyelectrolytes are dissociated in water, adsorbed to oppositely-charged suspended particles, neutralize the electric charges, and then bring about coagulation by bridging the interspace of the particles by themselves.

### 3. Coagulation Methods and Effect Parameters

The coagulation / flocculation takes the following four steps of dosing coagulants to wastewater, diffusing coagulants into wastewater, mixing coagulants and particles, and agitating to increase the size and density of floc. Mixing intensity and pH greatly influence producing larger and heavier floc<sup>4</sup>.

#### A. Mixing Effect on Coagulation

Increasing the number of contacts among particles is essential to more effectively form coagulation. Higher concentration and particle ununiformity are desirable for doing so. Mixing speed has a great impact on coagulation. Generally, strong and rapid mixing is required to increase the contacts of particles and coagulants, while gentle and slow mixing facilitates flocculation. Mixing conditions are calculated by velocity gradient (G) and detention time (T) in the mixing tank, as shown below:

$$G = (Pg_c / \mu)^{1/2} \quad (\text{m/sec/m})$$

where P: dynamics per unit volume ( $\text{kg} \cdot \text{m} / \text{m}^3 \cdot \text{sec}$ ) of fluid

$\mu$ : coefficient of viscosity ( $\text{kg} / \text{m} \cdot \text{sec}$ )

$g_c$ : gravitational conversion coefficient ( $\text{kg} / \text{m} \cdot \text{sec}^2$ )

As detention time in the mixing tank is T (sec), then  $G \cdot T$  becomes dimensionless. To form good floc,  $G \cdot T$  shall be in the range from  $10^4$ -  $0^5$ , and G of 100 for rapid mixing and G of 10 for slow mixing are thought to be appropriate.

## B. pH Effect on Coagulation

Solubility of hydroxide produced by inorganic coagulant varies greatly with the pH. For instance, aluminum sulfate forms floc quickly at around pH 8, as shown in Figure 2-4-8. The deviation from the solubility curve is caused by the isoelectric point, which is the point indicated by pH where surface electric potential and cataphoresis velocity become zero, of  $\text{Al}(\text{OH})_3$  being positioned at around pH 8, as shown in Figure 2-4-9. As the optimum pH in actual wastewater is affected by coexisting ions, however, it should be determined by a coagulation test.

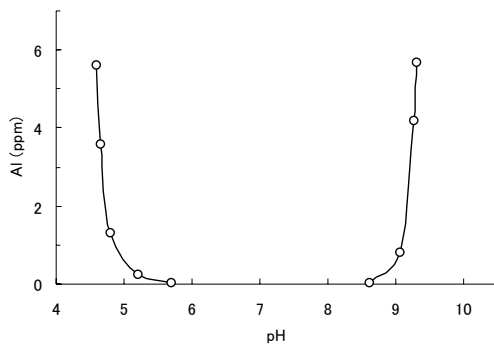

Figure 2-4-8 Solubility of aluminum hydroxide

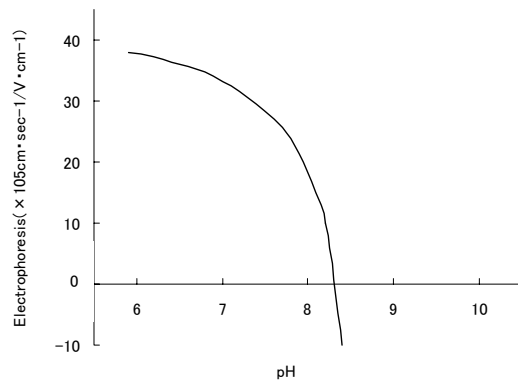

Figure 2-4-9 Isoelectric point of aluminum hydroxide

## REFERENCES

- 1) Sato H. *Water and Wastewater Handbook*, p. 180 (Maruzen, 1992).
- 2) Tsuno, H. *Environmental Sanitation Engineering*, p. 77 (Kyoritsu, 1995).
- 3) Asaoka, T. *Colloidal Chemistry*, p 64 (Sankyo, 1967).
- 4) Ide, T. *Industrial Wastewater and Treatment*, p. 147 (Gihodo, 1968)

## Chapter 5 Wastewater Purification by Biological Treatment

### 5.1 Aerobic Biological Treatment

#### 5.1.1 Basic Technology of Aerobic Biological Treatment

##### 1. Removal Mechanisms and Treatment Methods

The treatment process of organic wastewater by aerobic micro-organisms is called the activated sludge process. It utilizes metabolisms of micro-organisms for oxidizing and decomposing organic matter by following the three steps of organic substances in wastewater being adsorbed to activated sludge (agglomerated microbiology) within 1 to 20 minutes after

contact, organic substances being oxidized for microorganisms to gain energy to synthesize cells, and an oxidation autolysis of cells occurring due to a shortage of food for the microorganisms. These sequential reactions are expressed by Hoover<sup>1)</sup> et al. as shown below. At first, organic substances (C<sub>x</sub>H<sub>y</sub>O<sub>z</sub>) in wastewater are synthesized to activated sludge (C<sub>5</sub>H<sub>7</sub>NO<sub>2</sub>) by following biological oxidation:

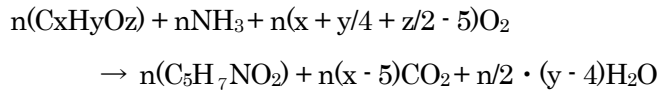

As activated sludge normally operates under a food shortage, while synthesizing cells it simultaneously oxidizes and decomposes part of the cell material in order to gain energy for synthesizing, as shown below:

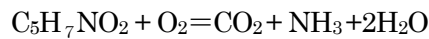

For instance, 1 g of synthetic wastewater containing milk sugar (8CH<sub>2</sub>O) and casein (C<sub>8</sub>H<sub>12</sub>N<sub>2</sub>O<sub>3</sub>) is converted to 0.53 g of activated sludge (C<sub>5</sub>H<sub>7</sub>NO<sub>2</sub>), and the remainder is decomposed to CO<sub>2</sub> and H<sub>2</sub>O. If half of this sludge is oxidized through endogenous respiration, then 0.265 g of excess sludge remain. Aerobic biological treatments using suspended sludge are classified into processes including the conventional activated sludge process, extended aeration process, contact stabilization process, step aeration process, and tapered aeration process. To maximize the three-step removal capabilities described before, some countermeasures are taken including setting the appropriate BOD-MLSS load (BOD kg / MLSS kg · d), equalizing sludge loading, and optimizing the oxygen supply, which lead to upgrading effluent quality, reducing excess sludge, stabilizing process operation. Biofilm reactor treatment uses an aeration tank in which fixed type media or floating type media are filled to secure stable biomass settlement. The plug flow type and complete mixing type are named after the special property of mixing. The former contributes to preventing bulking and the latter to lessening the shock load. At the planning stage of wastewater treatment for food processing, the selection of treatment methods or combination of those are studied to fulfill the purpose and local environmental conditions.

## 2. BOD Loading and Temperature Effect

With activated sludge treatment, the BOD removal rate is expressed by the

BOD-MLSS load (BOD kg / MLSS kg · d) and the rate used for design usually ranges from 0.02 to 0.4 (BOD kg / MLSS kg · d). The MLSS concentration in the aeration tank usually used for design is between 2,000 and 5,000 mg/ℓ, depending on the process conditions. Assume that the BOD-MLSS load (BOD kg / MLSS kg · d) is 0.2 and the MLSS concentration is 5,000 mg / ℓ. The volumetric loading rate is calculated as 1.0 kg / m<sup>3</sup> · d. Normally a slightly high BOD-MLSS load makes the effluent clearer, and the clearest effluent is attained with a BOD-MLSS load of 0.1. A lower BOD-MLSS load, such as one of about 0.01, increases effluent turbidity due to sludge dispersion although the BOD and COD removal rates are not decreased. Change of BOD concentration  $Y_t$  by the time elapsed is expressed by the equation shown below<sup>2)</sup>:

$$Y_t = L(1 - 10^{-kt})$$

where L: initial BOD concentration (mg/ℓ)  
t: elapsed reaction time (day)  
k: coefficient of removal velocity (1/day)

k is affected by the temperature, and the effect of the temperature in the range from 10 °C to 30 °C is computed by the formula shown below:

$$k_1/k_2 = \theta^{(t_1 - t_2)}$$

where  $\theta$  : temperature coefficient, 1.047  
 $k_1$  : removal velocity at temperature  $t_1$   
 $k_2$  : removal velocity at temperature  $t_2$

The above equation indicates that the removal velocity increases by 4.7% when the water temperature increases by 1 °C, by 58% with a 10 °C increase, and by 2.5 times with a 20 °C increase. Since the actual aeration tank in wastewater treatment is operated at a temperature from 5 °C to 20 °C, the removal rate at a predictable low temperature and allowable fluctuation of the MLSS concentration should be considered in determining the BOD-MLSS load at the design phase.

### 3. Oxygen Demand and Aeration Methods

The oxygen demand for oxidizing organic matters is calculated from TOD or ultimate

BOD, which is gained by extrapolation from BOD<sub>5</sub>. Though the oxygen demand depends on the contents in the wastewater, it is normally about 1.5 times BOD<sub>5</sub>. The oxygen supply capacity of aerator N (kg/h) is calculated as shown below:

$$N = N_0 / \left[ \frac{(C_{sw} - Cl)}{C_w} \right] (1.024)^{(t-20)} \alpha$$

where  $N_0$ : oxygen demand (kg/h)

$C_w$ : saturated oxygen concentration in water (mg/l, 20 °C, 1atm)

$C_{sw}$ : saturated oxygen concentration in wastewater (mg/l, 20 °C, 1atm)

$Cl$ : operating oxygen concentration (mg/l)

$t$ : operating temperature (°C)

$\alpha$ : ratio of oxygen transfer velocity of wastewater to water

The figures used in designing wastewater treatment of food processing are:

$$C_w = 8.84, C_{sw} = C_w \times 0.9, \alpha \doteq 0.9$$

$Cl = 1 \sim 2$  mg/l in conventional activated sludge process operated normally

$3 \sim 5$  mg/l for extended aeration process and lagoon

The equation indicates that the oxygen concentration in the aeration tank is definitely dominated by the oxygen supply capacity of the aerator, which has a great influence on the power consumption of the aerator. Oxygen concentration for rate-determination in BOD removal velocity is said to be about 0.2~0.5 mg/l, which has been confirmed by experimentation. For aeration methods, there are diffusers (fine bubbles, coarse bubbles, etc.), mechanical aerators (fixed bed and floating types), submerged aerators, ejectors, etc. The aeration methods are determined after fully considering mixing patterns suitable to process technology (plug flow, complete mixing), cost-effectiveness, easiness of maintenance and operation, local environment conditions.

#### 4. Nutrient Requirements

For biological treatment, nitrogen and phosphorus are needed at a rate of BOD: N: P = 100: 5: 1. Since phosphorus is generally short in food processing wastewater, phosphorus is added in the form of phosphoric acid or ammonium phosphate.

## 5. Effect of pH

The allowable pH in the biological process ranges between approximately 4 and 9, which varies depending on the substrates in the wastewater. The optimum pH is around 7 for food processing wastewater treatment. Wastewater from food factories quickly becomes putrid and is often decomposed into organic acids before arriving at wastewater treatment plants, as verified by the low pH. These organic acids are easily oxidized, converted to carbon dioxide in aeration tanks, and released into the air by aeration, resulting in the pH in aeration tanks going up. As basic anhydride salts generated by oxidation react with carbon dioxide to produce carbonate that can act as a buffer, the water in the aeration tanks is kept slightly alkaline. As alkali in detergent used in production processes also reacts with the carbon dioxide created by the decomposition of organic matters and carbonate, the pH in wastewater goes down. Therefore, pH control in wastewater treatment in food processing factories is not often needed.

### 5.1.2 Conventional Activated Sludge Process

The conventional activated sludge process is generally designed at a BOD-MLSS load range of 0.2~0.4 (BOD kg/ LSS kg · d) and an MLSS range of 3,000~5,000 mg/ℓ. The detention time in the aeration tank is about 8 hours. The removal rates of BOD and SS are high, and clarified effluent containing only a few mg/ℓ of BOD and SS is produced. The settling tank is designed complying with the light load specifications. Excess sludge generated in food processing wastewater treatment is generally about 20~30% of influent BOD by weight.

### 5.1.3 Extended Aeration

Extended aeration is designed at a BOD-MLSS load ranging from 0.03 to 0.05 (BOD kg/MLSS kg · d) and an MLSS ranging from 3,000 to 6,000 mg/ℓ. Therefore, the detention time in the aeration tank is about 24 hours. One advantage in this process is the generated excess sludge being minimized by lowering the BOD-MLSS load and by auto-oxidizing sludge in endogenous respiration. This results, however, in sludge flocculation being weak (dispersed), and the effluent quality is inferior to conventional activated sludge process. The process is suited for small volume wastewater, which is often used in batches. In this case, aeration is halted for several hours a day, and supernatant is discharged after the gravitational settling of sludge in the tank. While the main advantages of the process are the simplicity of the system and almost no necessity for sludge treatment, it has some disadvantages such as the high

construction cost, large space requirements, lower effluent quality, and limited locations such as areas where the effluent standards are not strict.

#### 5.1.4 Aerobic Biofilm Process with Floating Media

This process uses plastic floating media, which is slightly lighter than water and is filled into the aeration tank, and treats the wastewater with microorganisms grown on the surface of the floating media. There are many types of media with different shapes and materials. The media shown in Figure 2-5-1, for example, has a surface area of  $500\text{m}^2/\text{m}^3$  and is shaped to be easily fluidized and hold biomass on the surface. These media, moving freely and smoothly due to the bubbling air, facilitate the dispersion and retention of air bubbles in the water for longer periods of time, consequently increasing the oxygen transfer rate. Although the media are trapped by screens at the aeration tank outlets, there are fine size SS leaks. As reducing the SS to lower than  $100\text{ mg}/\ell$  with gravity settling is difficult, these fine size SS are removed using coagulation-settling or coagulation-floatation. None of the sludge removed in this process is returned to the aeration tank from the coagulation-settling tank or coagulation-floatation unit. The aerobic biofilm process can adjust the removal rate at a level corresponding to the BOD load-biomass, and high concentration wastewater, with as high as a BOD of  $5,000\text{ mg}/\ell$ , can therefore be directly treated. The process for pre-treating activated sludge does not require diluting the wastewater, unlike the conventional process. When PABIO Mover is filled into the tank at a ratio (filled media volume / aeration tank volume) of 67%, and the effluent BOD is aimed at below  $20\text{ mg}/\ell$ , then the BOD removal rate is related to the filling ratio as shown in the criteria below:

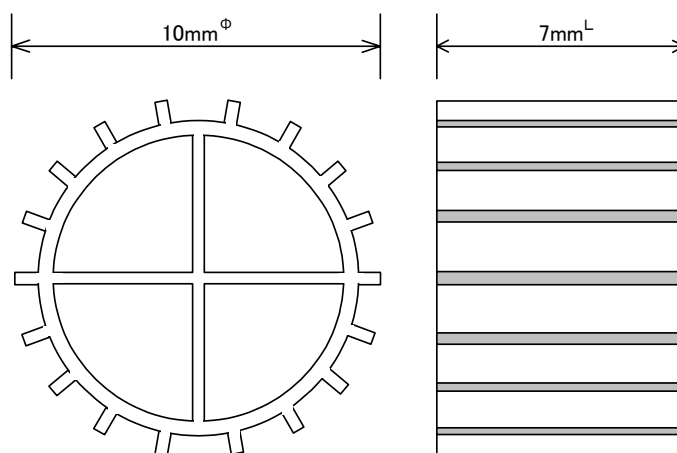

Figure 2-5-1 Media (Produced by Kaldnes)



BOD removal rate	>99%	BOD 1.5 kg/m <sup>3</sup> · d (water temp. 10 ~ 15 °C)
		BOD 2.0 kg/m <sup>3</sup> · d (water temp. >15 °C)
	>90%	BOD 2.0~4.0 kg/m <sup>3</sup> · d
	70 ~ 90%	BOD 4.0~10 kg/m <sup>3</sup> · d

This process with the coagulation-settling process will make the treatment facility a compact one for treating low concentration wastewater.

### 5.1.5 Activated Sludge Process with Membrane Separation

In this process, the sludge is separated from the wastewater by a fine filtration membrane with a 0.4 μm pore size instead of the settling tank that uses a dissolving air floatation unit with a sand filter, which is used in activated sludge processing, a basic technology in organic wastewater treatment. This fine filtration membrane is a basic technology in organic wastewater treatment. The two commercialized processes are the membrane modules being submerged in aeration tanks and the mixed liquor being pressure-fed by pumping it into the membrane modules installed outside of the aeration tank. The applicable influent BOD concentration is up to about 3,000 mg/ℓ. Although the effluent quality depends on the influent concentration, good quality effluent, with less than 10 mg/ℓ for BOD and less than 5 mg/ℓ for SS, is steadily produced usually. When advanced treatment is not required, the cost is higher than that of conventional secondary treatment. In addition, it has some extra work like rinsing and replacing membrane modules.

### 5.1.6 Lagoon

Lagoon, oxidation ditch, extended aeration, etc. are similar in their basic technology, but are named differently. The distinctions between them are not clearly defined. The lagoon used in Japan is an aerobic biological wastewater treatment process without a settling tank designed at 0.02~0.07 of the BOD-MLSS load (BOD kg/MLSS kg · d) and 2,000 mg/ℓ of MLSS. This process does not dispose of excess sludge, but leaves it at the bottom as sediment. Since the detention time in an aeration tank extends for over a week, this necessitates a huge tank volume. A pond dug in the ground with partial reinforcement is often used for aeration. When a settling tank is not provided, the inflow and aeration are halted, and the sludge settles quietly. Then the supernatant is discharged. A floating type aerator is used to handle the water level

fluctuations. DO in a lagoon is usually kept at a high level of around 5 mg/l which results in substantially power requirements for driving the aerator and agitating the sludge to prevent it from settling to the bottom. The two operations need almost the same power. The power requirement totals 3~4 times the conventional activated sludge process or 0.01 kW/m<sup>3</sup> of the aeration tank volume as a criterion. As in the extended aeration process, the effluent quality is lower than for the conventional activated sludge process. Still, the process is workable at low temperatures, easily operable, and generates less sludge while achieving stable treatment. Therefore, many lagoons are used in starch factories in Hokkaido where the effluent quality standards are not strict and wide spaces are available.

## **5.2 Anaerobic Treatment**

### **5.2.1 Basic Technology for Anaerobic Treatment**

#### 1. Mechanism and characteristics of Reactions

Three metabolic stages proceed sequentially in the anaerobic process. Polymeric materials are hydrolyzed in the first stage, then decomposed into volatile fatty acids (VFA) in the second stage, and decomposed further to produce methane gas in the third and final stage. Some inorganic materials such as sulfate and nitrate are also reduced. The typical decomposition pathway to methane production and the microbiological groups involved in the anaerobic treatment are outlined in Figure 2-5-2. The polymeric organic materials in wastewater are decomposed by hydrolysis bacteria into small size molecular compounds like monosaccharides, aromatic compounds, amino acids, longer-chain fatty acids, and then are decomposed by acidogenesis bacteria into VFA. VFA continues to be decomposed by acidogenesis bacteria and symbiotic acetogenesis bacteria, which are composed of hydrogenotrophic acetogenesis bacteria and hydrogenotrophic bacteria, into acetic acid. Finally, acetic acid is converted to methane and carbon dioxide by methanogenesis bacteria. The substrates directly converted to methane include methanol and formic acids. Sulfides are often involved in food wastewater and reduced to hydrogen sulfide. Experiments demonstrate that sulfate decreases methane gas production because sulfate-reducing bacteria, with stronger affinity for hydrogen, preferentially utilize hydrogen and produce hydrogen sulfide<sup>3)</sup>. Inhibition by sulfate on anaerobic microorganisms depends on the concentration of hydrogen sulfide generated in the reactor and pH. If the ratio of S<sup>2-</sup> /TOC exceeds about 0.3, the substrate shortage restrains the sulfate reducing reaction from producing hydrogen sulfide. Consequently,

the surplus sulfate is run out without any reaction or inhibition<sup>4)</sup>. Although many aspects in anaerobic mechanisms are not solved yet, many anaerobic treatment plants are working in the food industry, which proves that the system is already industrialized for stable operations under well-established control systems. The features in an anaerobic process are summarized by comparing them with the activated sludge process:

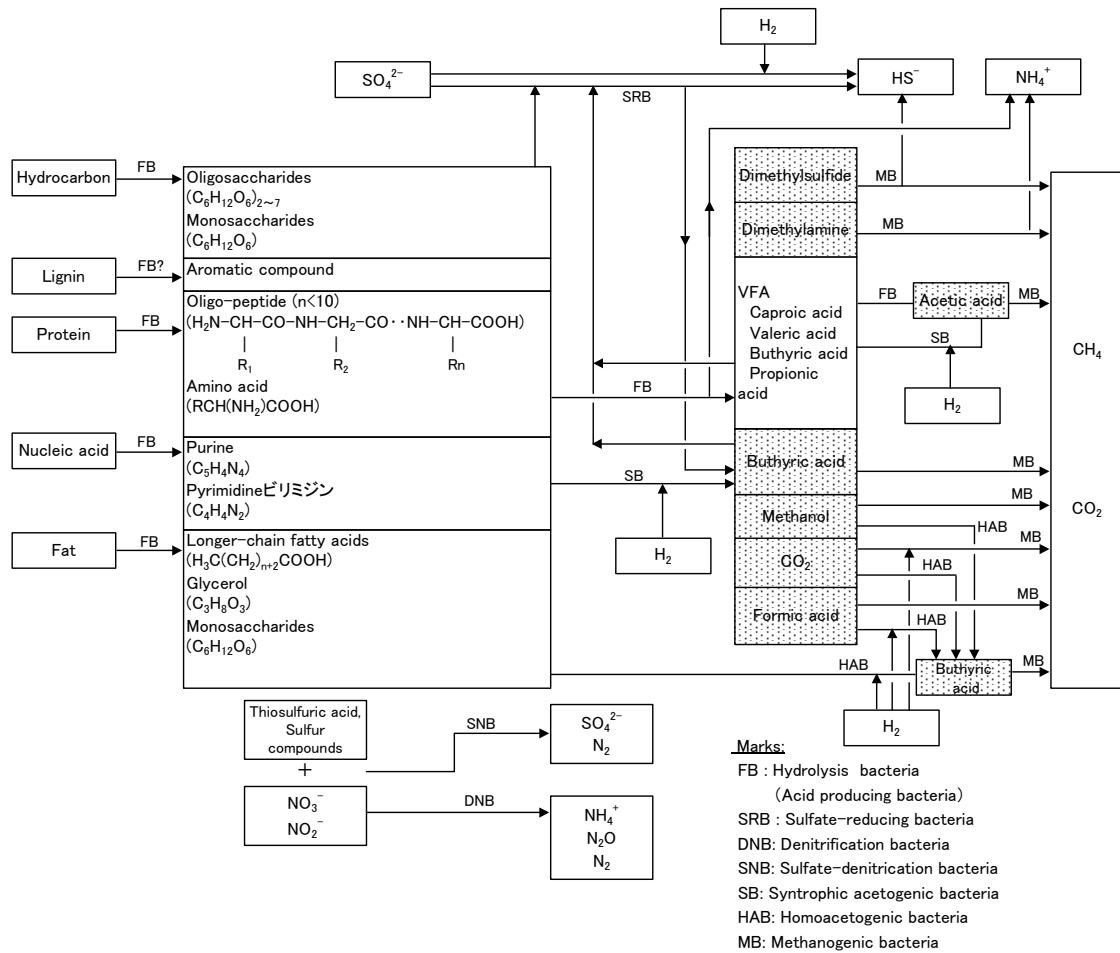

Figure 2-5-2 Decomposition path in anaerobic treatment

- A. recovering methane from organic wastes in wastewater (0.35 Nm<sup>3</sup> CH<sub>4</sub>/ kg TOD).
- B. saving power consumption by 30~50% compared to solely using the activate sludge process, when an anaerobic process as a pretreatment is combined with the activated sludge process.
- C. saving sludge disposal cost due to less sludge generation, at 15~60% of the activated sludge process.
- D. saving chemical costs due to less nutrient requirements, at 10~20% of the activated sludge

process

E. less operation factors, easy operation, and stable operation.

## 2. Temperature Effects<sup>5)</sup>

In the anaerobic process, there are three kinds of digestion at different temperature levels. They are thermophilic digestion at around 55 °C, mesophilic digestion at around 36 °C, and normal temperature digestion. Mesophilic digestion is primarily used in food processing wastewater treatments. Thermophilic digestion is not popular in spite of the advantages of a lower substrate-sludge yield ratio and higher gasification rate because less species of thermophilic bacteria and a low growth yield lag behind the decomposing organic acids produced by the precursor reaction, which inhibit methanogenic biodegradation. The largest biomass volume can be seen in experiments in the mesophilic process, then in the normal temperature process (20~25 °C), and lastly in the thermophilic process. The highest degradation capacity per unit volume is in the mesophilic process, then the thermophilic process, and lastly the normal temperature process. The higher degradation capacity per unit volume in the thermophilic process compared to the normal temperature process is thought due to the higher reaction velocity.

## 3. pH and Alkalinity Effects

Organic compound degradation starts off with hydrolysis by acidogenesis bacteria at 4.0~7.8 pH, which is thought to be the optimum. The optimum pH for methanogenesis bacteria is thought to be between 7.0~8.8. Therefore, acidogenesis and methanogenesis are sometimes reacted in separated reactors, which is the two-phase anaerobic process. Substrates in wastewater in food factories, except for wastewater containing a high concentration of organic suspended solids, are easily and swiftly decomposed into organic acids. Therefore, the acidogenesis process does not disturb other processes, and the methanogenesis process, which decomposes organic acids into methane, dominates the overall reaction velocity. The treatment is normally carried out in a single reactor where pH is kept at around 7 with a mixed culture of acidogenesis bacteria and methanogenesis bacteria. Another reason for the single phase is attributed to saving construction costs and simplifying operation. In a single reactor, the optimum pH is in the 6.5~7.5 range, and methane production gradually deteriorates below a pH of 6.0. A longer time is needed to resume activity below a pH of 5.0. For example, once

organic acids are overproduced by overloading, methanization lags behind acid production, and the organic acids (VFA) generated in the acidogenesis process and carbonate ( $H_2CO_3$ ) surpass the usable alkalinity. The pH declines, and methane production deteriorates in spite of dosing large quantities of alkali, ending in a vicious cycle. Experimental results<sup>5)</sup> for Steffen Wastes (wastewater discharged from the process to recover cane sugar out of spent theriac) are shown in Figure 2-5-3 and Figure 2-5-4. For such a case, the pH level in a reactor shall be resumed by lowering the operation load. The buffer action associated with alkalinity plays an important role in stabilizing the pH in the reactor. Both alkalinities from wastewater origin and those generated in anaerobic digestion are utilized for this neutralization. Alkalinities generated in anaerobic digestion are composed of cations emitted from protein, organic acids alkali, sulfate, nitrate, nitrite, etc. For instance, protein reacts as shown below:

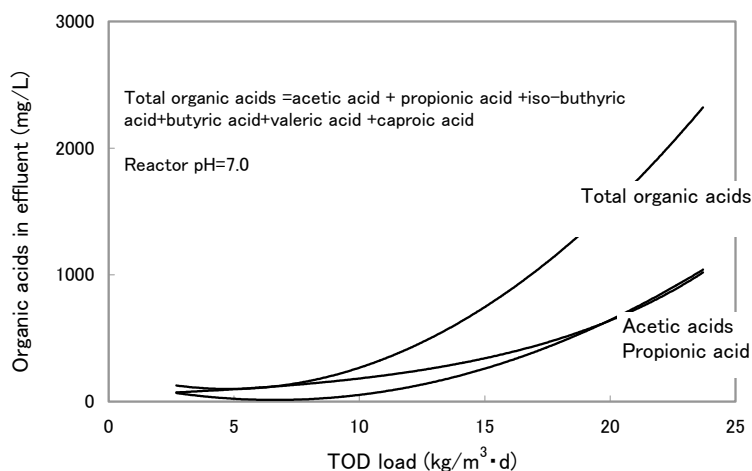

Figure 2-5-3 Organic acids accumulation versus TOC load increasing

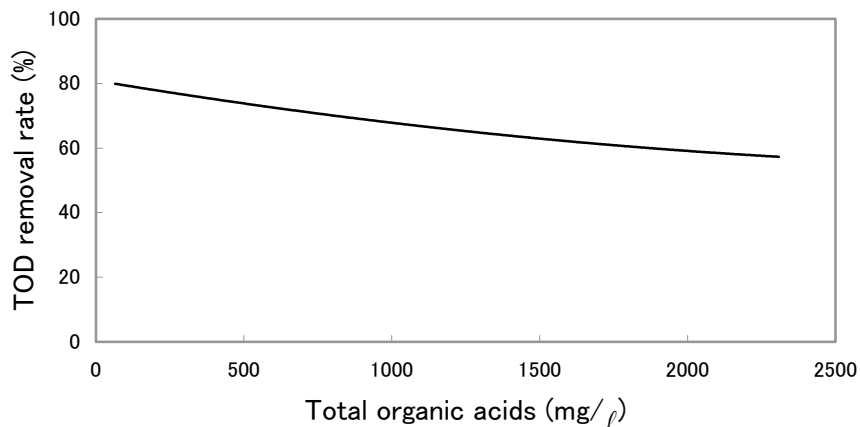
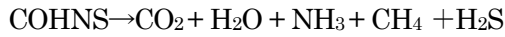

Figure 2-5-4 TOD removal versus organic acids concentration in effluent



to generate ammonium carbonate which acts as a buffer.

On the contrary, hydro carbons, saccharides, organic acids, alcohols, etc. do not generate alkalities because no cation is emitted while decomposing. When alkalinity originating in wastewater and metabolism is short for neutralization, dosing alkali like caustic soda is needed.

#### 4. Excess Sludge Generation<sup>6)</sup>

The excess sludge generation rate is experimentally summarized by Henze et al<sup>8)</sup> as shown in Figure 2-5-5. Actually, anaerobic processes are operated at a 0.3~0.5 range of COD loading (kg COD/ kg VSS · d). Then the excess sludge generation rate becomes a 0.03~ 0.12 range (kg VSS / kg soluble removed COD), as obtained from Figure 2-5-5. This rate is comparatively small with 0.2~0.3 (kg VSS / kg soluble removed COD) of excess sludge generation rate in the activated sludge process.

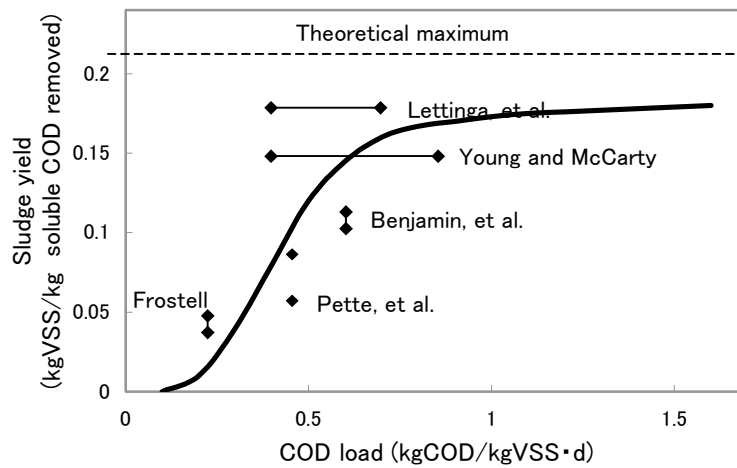

Figure 2-5-5 Observed yield coefficients, soluble COD in anaerobic processes

#### 5. Nutrients and Trace Metals

In biological wastewater treatment, inorganic nutrients and trace metals are required for the microbial metabolism. The anaerobic process also requires nitrogen and phosphorus at a minimum level, in the same way as the aerobic process requires nutrients at a ratio of BOD: N:

P = 100: 5:1. As anaerobic bacteria contain 10.5% nitrogen and 1.5% phosphorus in VSS (volatile suspended solids)<sup>7)</sup>, the required nitrogen in influent COD can be obtained from the relation between the COD load and excess sludge generation in Figure 2-5-5 and is illustrated in Figure 2-5-6. The phosphorous requirement is estimated from the N / P ratio in microbiology, i.e. N: P = 7:1. If COD loading is 0.5 (kg COD/kg VSS · d) in a reactor, then the ratio becomes COD: N: P = 100: 0.6: 0.08 roughly, showing that the N and P requirement is far less than for the aerobic process. Trace metals in Table 2-5-1 are needed for flocculation of anaerobic bacteria, c production of co-enzymes, activation, and related items<sup>8)</sup>.

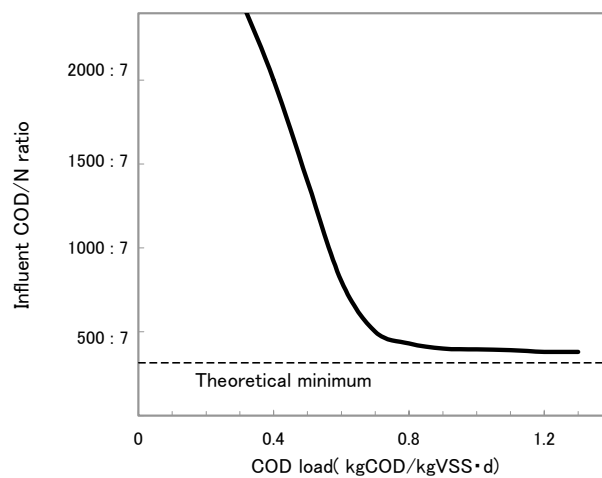

Figure 2-5-6 COD/N-ratio as function of organic load

Table 2-5-1 Trace metals effects for anaerobic treatment

Metals	Effective concentration in experiment (g/m <sup>3</sup> )	Effects	Researchers
Fe <sup>++</sup>	0.2	• sedimentation of sulfide • coagulation • ingredients of cell membrane	Speece, et.al.
Ni <sup>++</sup>	(0.01 ?)	• co-enzymes of methanogenesis bacteria • formation of F430	Thauer  Murray, et.al.
	0.006	• activation	
Mg <sup>++</sup>	0.01 ~ 0.02	• coagulation	Lettinga, et.al.
Ca <sup>++</sup>	0.01 ~ 0.04	• coagulation	Lettinga, et.al.
Ba <sup>++</sup>	0.01 ~ 0.1	• coagulation	Lettinga, et.al.
Co <sup>++</sup>	0.01	• formation of B12	Speece, et.al.
	0.003	• activation	Murray, et.al.
SO <sub>4</sub> <sup>--</sup>	0.02	• activation	van den Berg

### 5.2.2 Process

In the early days, the anaerobic treatment used the reaction of suspended anaerobic microorganisms in a complete mixing reactor. In the process several problems were found including the adsorption force of anaerobic sludge to substrates being weaker than in the case of activated sludge, high loading operation being difficult in the complete mixing reactor because the influent substrates contact at a concentration level as low as that in the effluent, and the necessity of a settling tank to maintain the microbial concentration. To overcome these problems, plug flow type reactors maintaining a high concentration of biomass were developed. Over a 100 units are now working, mainly in food factories. As to the plug flow type reactor, the upflow type is thought to perform than the downflow type because the influent flowing in at the bottom has better contact with anaerobic microbiology condensed there<sup>9)</sup>. Two methods are popular in order to maintain a high biomass concentration. They are growing biomass on the surface of media skillfully shaped to hold biomass without clogging and using self-granulation to form bio-granules with high density and high settlability. The former is generally called the fixed bed method and a sample of the media filled in the reactor is shown in Picture 2-5-1. As the media is lighter than water it floats, but it is not fluidizing. The latter is generally named the UASB (Upflow Anaerobic Sludge Blanket) method, which holds the settlable granular shape biomass shown in Picture 2-5-2 in the reactor.



Photo 2-5-1 Media of fixed bed anaerobic reactor



Photo 2-5-2 Granulated anaerobic sludge



### 5.3 Hybrid Process by Anaerobic and Aerobic

As the removal rates of BOD, SS, and other elements in the anaerobic process are lower than those in the aerobic process, the direct discharge of effluent is not allowed in areas where the effluent standards are strict. Therefore, except in areas where direct discharge is allowed into sewers, the effluent from the anaerobic process is generally treated with the secondary aerobic process. Taking the advantages of the anaerobic process, it is practically used as explained below<sup>10</sup>:

#### A. For Pre-treatment before Discharging to Sewer

A brewery factory was built in an area where sewer service was available, and an anaerobic treatment facility for the pre-treatment was installed. The schematic flow, performance, and cost comparison with the aerobic process are shown in Figure 2-5-7, Table 2-5-2, and Table 2-5-3.

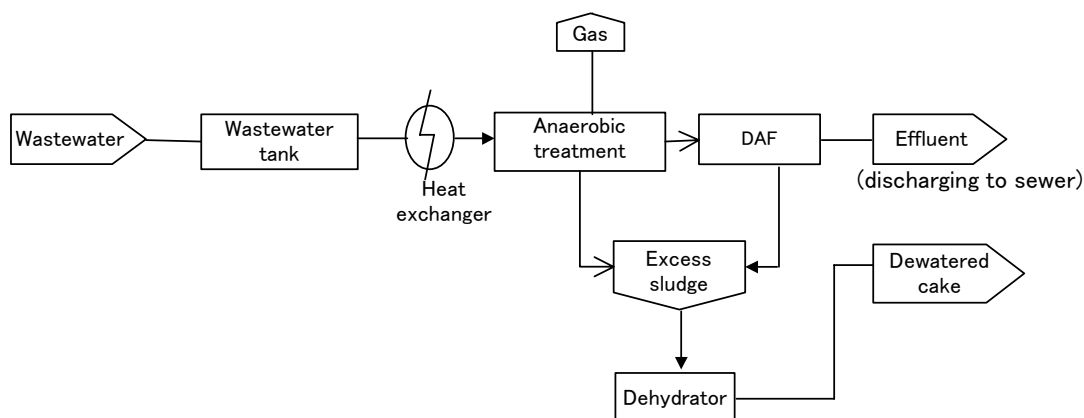

Figure 2-5-7 Schematic flow of beer brewery wastewater treatment (discharging to sewer)

Table 2-5-2 Anaerobic treatment results (for sewerage discharge) ,weekly average

Date		89.5.8~	89.5.15~	89.5.22~	89.5.29~
Wastewater volume	Q (m <sup>3</sup> /d)	2,710	3,560	3,460	3,820
Influent wastewater	TOD (mg/ℓ)	1,470	1,530	1,390	1,350
	BOD (mg/ℓ)	900	966	712	694
	SS (mg/ℓ)	140	357	260	143
Effluent from anaerobic treatment	TOD (mg/ℓ)	300	320	280	250
	BOD (mg/ℓ)	84	120	50	46
	SS (mg/ℓ)	140	150	140	120
Gas volume	G (m <sup>3</sup> /d)	1,100	1,210	924	969

Table 2-5-3 Cost comparison of anaerobic process with aerobic process (for sewerage discharge)

Items	Unit price (¥)	Anaerobic process + DAF <sup>※</sup>		Aerobic process	
		Consumption /d	¥/d	Consumption /d	¥/d
Power	18/kWh	3,200kWh	57,600	6,800kWh	122,400
Steam	3/kg	12,000kg	36,000	-	-
45% NaOH	40/kg	1,600kg	64,000	-	-
Coagulants	1,400/kg	4kg	5,600	15kg	21,000
Desulfurizing agent	170/kg	4.2kg	714	-	-
Sludge disposal	10,000/m <sup>3</sup>	1.5m <sup>3</sup>	15,000	6m <sup>3</sup>	60,000
Methane gas	※※ 28,000/k <sub>ρ</sub>	2kL	▲ 56,000	-	-
Total			122,914		203,400
Difference			▲ 80,486		

※Dissolved Air Flootation unit, ※※as A-heavy oil

### B. For Increasing Production

As a food processing factory expanded its production lines, an anaerobic treatment process was introduced as pretreatment in order to reduce the load of the existing activated sludge treatment plant. The flow, performance, and cost comparison with the aerobic process are shown in Figure 2-5-8, Table 2-5-4, and Table 2-5-5. In this case, the operating costs were apparently reduced, and the process also contributed largely to eliminating bulking in the existing activated sludge treatment plant. This was a case where the anaerobic process was added to the existing activated sludge process. In the case of completely new construction, a system combining anaerobic and aerobic processes is more economical than a system only using the aerobic process. The former is slightly more costly than the latter for the construction cost, but the operation cost of the latter is far less. The savings can compensate for the difference in the construction costs within a year.

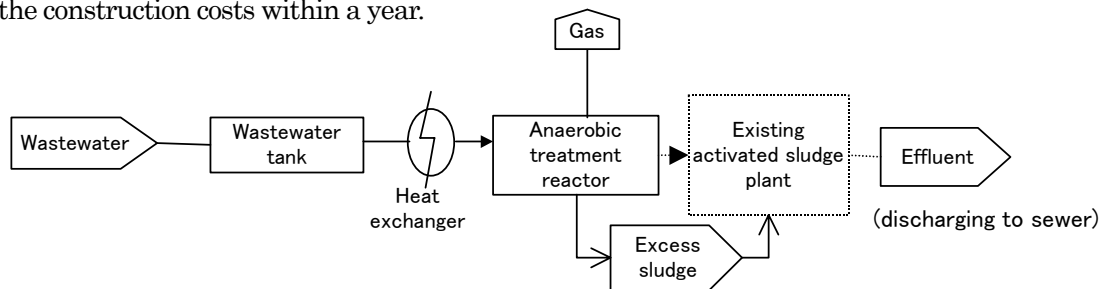

Figure 2-5-8 Schematic flow of food processing wastewater treatment (discharging to sewer)

Table 2-5-4 Anaerobic treatment results (for factory expansion), weekly average

Date		88.9.27~	88.11.28~	89.2.1~	89.2.8~
Wastewater volume	Q (m <sup>3</sup> /d)	285	307	330	335
Influent wastewater	TOD (mg/ρ)	21,257	19,364	23,743	25,229
	BOD (mg/ρ)	15,143	13,000	14,671	15,879
	SS (mg/ρ)	1,784	1,889	4,270	4,776
Effluent from anaerobic treatment	TOD (mg/ρ)	3,188	3,290	5,311	5,687
	BOD (mg/ρ)	1,211	1,210	2,709	3,245
	SS (mg/ρ)	715	698	1,393	1,792

Table 2-5-5 Cost comparison of anaerobic process with aerobic process (for factory expansion)

Items	Unit price (¥)	Anaerobic+ aerobic process		Aerobic process	
		Consumption /d	¥/d	Consumption /d	¥/d
Power	18/kWh	1,628kWh	29,304	3,222kWh	57,996
Desulfurizing agent	170/kg	47kg	7,990	-	-
Coagulants for dehydration	22/kg-DS	460kg-DS	10,120	1,260kg-DS	27,720
Sludge disposal	10,000/m <sup>3</sup>	1.53m <sup>3</sup>	15,300	4.2m <sup>3</sup>	42,000
Methane gas	※28,000/k <sub>l</sub>	2.07k <sub>l</sub>	▲57,960	-	-
Total			4,754		127,716
Difference			▲ 122,962		

※as A-heavy oil

### C. Saving Energy and Resources

There was a factory that previously treated high concentration (BOD about 5,000 mg/l) wastewater with the activated sludge process after diluting it with low-grade industrial fresh water. Afterward, the factory introduced the anaerobic process for pre-treatment and saved the fresh water cost. At the same time, the whole wastewater treatment was rationalized. The schematic flow, performance, and cost comparison with the aerobic process are shown in Figure 2-5-9, Table 2-5-6, and Table 2-5-7. In this case also, the total cost of combining the anaerobic and aerobic processes was higher than that of the aerobic process alone, but due to the savings of the operation costs, the difference was compensated for within a year.

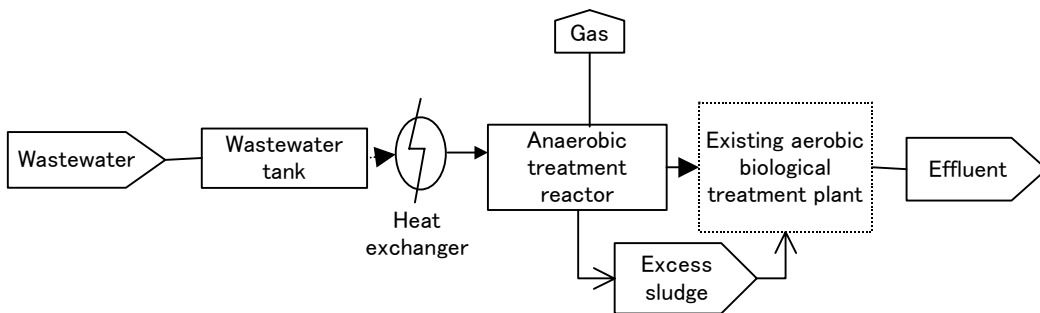

Figure 2-5-9 Schematic flow of high concentration wastewater treatment (for energy saving)

Table 2-5-6 Anaerobic treatment results (for energy saving), weekly average

Date		89.3.13~19	89.4.10~16	89.5.15~21
Wastewater volume	Q (m <sup>3</sup> /d)	950	900	1,300
Influent wastewater	TOD (mg/l)	8,500	12,000	10,000
	SS (mg/l)	150	200	150
Effluent from anaerobic treatment	TOD (mg/l)	3,600	4,800	3,000
	SS (mg/l)	300	220	140
Gas volume	G (m <sup>3</sup> /d)	2,000	2,600	3,100

Table 2-5-7 Cost comparison of anaerobic process with aerobic process (for energy saving)

Items	Unit price (¥)	Anaerobic+aerobic process		Aerobic process	
		Consumption /d	¥/d	Consumption /d	¥/d
Power	18/kWh	5,224kWh	94,032	15,808kWh	284,544
Steam	3/kg	4,330kg	12,900	-	-
Desulfurizing agent	170/kg	12.4kg	2,108	-	-
Dilution water	30/m <sup>3</sup>	-	-	2,000m <sup>3</sup>	60,000
NaOH	40/kg	1,050kg	42,000	-	-
Urea	100/kg	415kg	41,500	822kg	82,220
Phosphoric acid	160/kg	143kg	28,880	271kg	43,360
Ferric chloride	26/kg	56kg	1,456	150kg	3,900
Polyelectrorite	1,200/kg	7.8kg	9,360	21kg	25,200
Sludge disposal	10,000/m <sup>3</sup>	5.6m <sup>3</sup>	56,000	15m <sup>3</sup>	150,000
Methane gas	※ 28,000/kL	3.2kL	▲ 89,600	-	-
Total			198,636		649,224
Difference			▲ 450,588		

※ as A-heavy oil

#### REFERENCES

- 1) N. Porges, L. Jaswicz, & S. R. Hoover. *Principles of biological oxidation*, Biological Treatment (1953).
- 2) Naitoh, Y., et al. *Industrial Wastewater Treatment*, p. 69 (Gihodo, 1958).
- 3) Matsui, S., et al. Sulfate Reduction Bacteria, *Kankyo Gijutsu*, 18 (4), p 229 (1989).
- 4) Hogetsu, A. et al. A Study on Sulfate Ion on Anaerobic Degradation in Synthesis Wastewater, *Kankyo Gijutsu*, 18 (7), p. 418 (1989).
- 5) Hogetsu, A. et al. A Study on Fermentation Temperature and Performance in Anaerobic Digestion, *Water Engineering*, Vol. 30, No. 1 (1989).
- 6) Hogetsu, A. Basics in Anaerobic Treatment, *The Best Treatment of Food Processing Wastewater Handbook*, p. 46 (Science Forum, 2002).
- 7) Speece, R.E., et. al. *Nutrient requirements and biological solids accumulation in anaerobic digestion*, Proceeding of the international conference, Pergamon Press, Oxford UK, p. 305 (1962).
- 8) Henz, H., et. al. Anaerobic treatment of wastewater in fixed bed film reactor, A literature review, *Wat. Sci. Tech.* 15, (1983).
- 9) Weiland, P., et. al. *Anaerobic Digestion 1988*, Proc. 5th Int. Symp. On Aerobic Digestion. Ed. Pergamon Press. 146 (1988).
- 10) Hogetsu, A. Energy Recovery from Industrial Wastewater by Anaerobic Digestion, *Water and Wastewater*, Vol. 33, No. 4 (1991).

## Chapter 6 Advanced Treatment Process and Reuse

The advanced treatment in food processing factories aims at discharging effluent after reducing the residual BOD, SS, nitrogen, phosphorous, and other items. In reuse, the necessary treatments are applied to effluent water to meet the requirement of the points of use.

### 6.1 Removal of Residual BOD, COD, SS

#### 1. Biological Treatment

The effluent treated by the activated sludge process in food processing factories normally contains 5~15 mg/ℓ of BOD, 10~40 mg/ℓ of COD, and 5~20 mg/ℓ of SS. Residual BOD in the effluent originates in un-reacted leaking materials, byproducts of metabolism and micro SS, and is generated from the activated sludge process. Even when BOD in wastewater containing hardly-biodegradable substrates is reduced, high COD is still sometimes detected in the effluent. Therefore, further application of biological treatment is not effective for substantially reducing BOD, COD<sub>Mn</sub>, and SS. Accordingly, in recent years, a process, which functions as a tertiary treatment by combining the secondary (biological) process and membrane filtration, is becoming popular. In this process, MF or UF membranes are used for removing sludge from the water instead of gravitational settling. The combined process of activated sludge plus membrane has two types as shown in Figure 2-6-1, which are the submerged type in that membrane modules are submerged in the aeration tank and the cross-flow type in that membrane modules are installed outside the tank. In the submerged type, the membrane surface is scoured by the shear force of the air-water up-flow, which continuously dislodges the accumulated sludge and prevents fouling. Filtration is made by suction from the pump. In the cross-flow type, a circulation pump pressurizes aeration tank liquid into the membrane module and separates the sludge from the water under the cross-flow. This type can separate a higher concentration of MLSS than the submerged type. As the hybrid process can maintain a higher MLSS level in the tank while preventing the wash-out of sludge due to bulking, it enables operating a high volumetric BOD load, twice as high as the normal activated sludge process. The effluent quality depends on the BOD concentration in the influent and the BOD loading rates. The relationships between the raw water concentration and the effluent qualities are shown in Table 2-6-1. Biological contactor is one of the biofilm treatments. In this process, several media shapes (string, honeycomb, corrugate, ring, etc.) are filled in the aeration tank, and biomass grows on these surfaces. As filtering is not provided in the process, a

combination of coagulation-settling and sand filter are usually need for solid-liquid separation afterward.

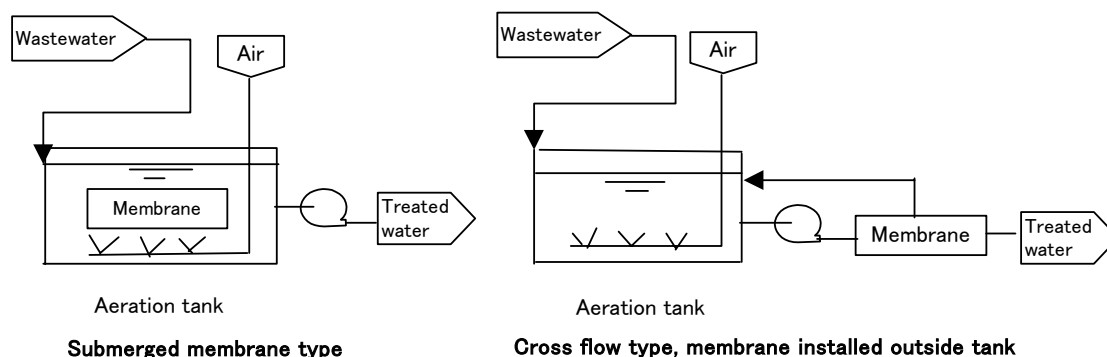

Figure 2-6-1 Hybrid activated sludge process combined with membrane separator

Table 2-6-1 Activated sludge process with membrane separator instead for settling tank

Items	Design standards (for reference)		Treatment results in food processing wastewater	
	Raw water	Effluent	Raw water	Effluent
BOD (mg/l)	1,000~3, 000	<20	538	<2
COD (mg/l)			154	<9
Oils (mg/l)	<100		80	<2
SS (mg/l)	<300	<5	231	<2

Remarks; MLSS (mg/l); 10,000~18,000, BOD-MLSS load (kg BOD/kg MLSS·d); 0.2~0.4, Volumetric loading (kg BOD/m<sup>3</sup>·d) 2.0~4.0 (for reference)·····was restricted by oxygen transfer capacity of aerator

## 2. Physical Treatment

Filtration is a representative type of physical treatment process that mainly aims at removing SS. In tertiary treatment, a dual medium, usually of sand and anthracite, rapid filter is widely used. The filtration velocity in the dual medium is 10~20 m/h, with a trap-rate at 6~8 kg SS /m<sup>2</sup> for SS larger than 5~10 μm in diameter. When the head loss increases from accumulated SS, a backwash starts automatically and dislodges the particles. A type of filter which does not need backwashing was developed and has been used. A batch of the filter media are taken out of tank, washed, and then replaced by another batch, thus circulating the media. The SS in the effluent of the dual media and the sand-circulating is less than 10 mg/l of the criteria SS.

## 3. Physical Chemical Treatment

Coagulation-sedimentation is a representative type of physical chemical process, which removes SS and COD that originated in colloidal fine organic particles. Inorganic

coagulants such as aluminium sulfate, PAC, and iron chloride are widely used together with polyelectrolyte to make settleable floc. Normally SS in the effluent is less than 10 mg/l, and nearly 30% of soluble COD in the secondary treatment effluent is usually removed, but a coagulation test is necessary for selecting coagulants and confirming the reaction conditions. As removal of COD by coagulation-sedimentation is a side effect accompanying the SS removal, activated carbon adsorption is generally thought to be the most effective method when COD removal is the main purpose of treatment. COD is adsorbed to micro pores on the surface of activated carbon, and, when the pores are saturated, the carbon is taken out of operation to be regenerated. Out of several types of activated carbon absorbers, a representative type is the batch, or discontinuous process, using a fixed bed in which saturated carbon is extracted and in its place fresh, active carbon is filled after interrupting the treatment operation. Another type is the continuous process using a fluidized bed. In it, saturated carbon extraction and refilling fresh, active carbon are carried out continuously without interrupting the operation. The extracted carbon is regenerated, usually in the factory when the quantity is large, but, when the quantity is small, the regeneration is outsourced to outside service facilities.

## 6.2 Denitrification

### 6.2.1 Basic Technology of Denitrification

Nitrogen in wastewater exists as organic or inorganic nitrogen, either in the form of dissolved N or suspended SS in water. It is removed by a biological or physical chemical process (chlorination, ammonium stripping, ion exchange, etc.). In food factories, nitrogen removal is applied mainly to the effluent from the activated sludge treatment. As nitrogen exists in the form of ammonia, nitrate, nitrite, and amine in food processing wastewater, biological denitrification is widely used due to technical and economic superiority. Biological denitrification consists of the nitrification process, which oxidizes ammonia to nitrate under aerobic conditions, and the denitrification process, which reduces nitrate to nitrogen gas under anaerobic conditions:

Nitrification

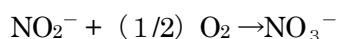
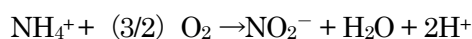

## Denitrification

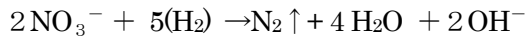
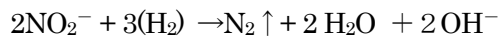

In this reaction 4.6 kg of oxygen are consumed to oxidize 1 kg of  $\text{NH}_3\text{-N}$ , and the oxidation of ammonia reduces the alkalinity in the water. As the nitrification bacteria are sensitive to temperature and pH, the pH control and temperature range maintenance shall be performed carefully to effectively promote the reaction. Furthermore, as raising the higher biomass holding as high as possible in the nitrification and denitrification processes is effective for reducing the reactor volume, each biofilm process, granulation method, and activated sludge process with membrane separation has been developed for practical use. Though the sequential nitrification-denitrification process could be done independently after secondary treatment by activated sludge process, it is better to incorporate it in the secondary process because using raw wastewater for utilizing substrates in it instead of using methanol and other substances as electron donors used in the independent process described before.

### 6.2.2 Processes

#### 1. Circulation between Anoxic-Aerobic Activated Sludge Processes

The denitrification process combining aerobic and anoxic processes is categorized as shown in Figure 2-6-2, looked at from the points of biomass isolation in the phases of BOD oxidation, and the nitrification and denitrification processes. As the nitrification process requires alkali and the denitrification process requires organic substrates dosing, a denitrification tank is installed before a nitrification tank from where the mixed liquor is circulated into the denitrification tank. This process is economical because the BOD in the influent is utilized for the denitrification, and the alkalinity generated in the denitrification tank is utilized in the nitrification tank, but the nitrogen removal rate is limited to about 70%. The process has been improved to the single phase sludge-circulating denitrification process, as shown in Figure 2-6-3, which mixes microorganism in BOD oxidation, nitrification and denitrification processes together. In this process preferred today, the denitrification tank is located before the nitrification tank, the effluent from the nitrification tank is circulated to the denitrification tank, and further denitrification occurs by adding organic substrates during the



later process to attain a better removal of nitrogen. Additional processes to improve the reaction efficiency by holding high density biomass, such as biofilm, granulation, and the hybrid activated sludge process combined with membrane separator, have been incorporated into the nitrification-denitrification process and have resulted in the circulation between the anoxic-aerobic activated sludge processes being diversified. The denitrification process requires a BOD of more than 3~5 times of nitrogen. If the BOD in the wastewater exceeds it, then electron donors are sufficient for the first stage denitrification tank, and economical denitrification becomes possible because electron donors like methanol are not needed. In this stage, the nitrogen removal rate is determined on the basis of the ratio between the BOD in the influent and the circulation volume of the nitrified liquid. When the BOD in the influent is sufficient, the removal rate is calculated as shown below:

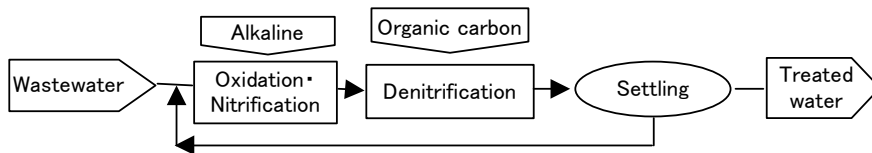

**A. Single phase sludge process**

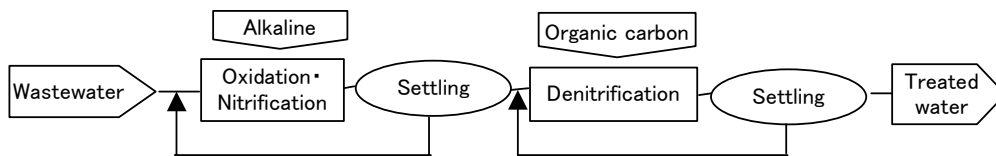

**B. Two-phase sludge process**

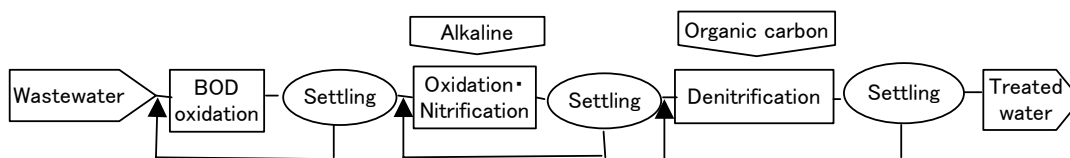

**C. Three-phase sludge process**

Figure 2-6-2 Circulation between aerobic and anoxic- activated sludge process

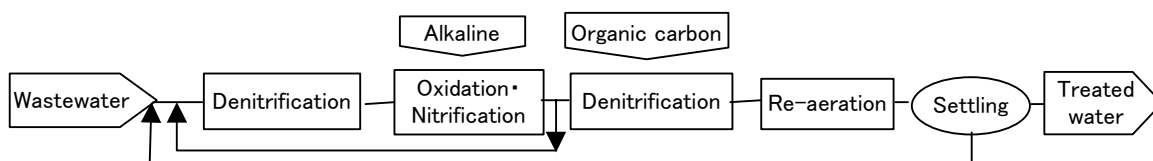

Figure 2-6-3 Single phase sludge-circulating denitrification process

$$\text{nitrogen removal rate} = n / (1 + n + r)$$

where                    n: circulation rate (circulation volume/ influent volume),  
                              r: sludge return rate (returned volume/ influent volume).

As the circulation rate increases, both the nitrogen removal rate and the power consumption of the pump increase. Therefore, the denitrification rate at the first stage is normally designed at between 50 and 80% and, for further nitrogen removal, a second stage denitrification tank is prepared after the oxidation/nitrification tank. Due to a shortage of BOD in the second stage denitrification tank, electron donors such as methanol shall be dosed. A re-aeration tank is provided to remove organic materials leaked from the denitrification tank, to recover dissolved oxygen, and to strip nitrogen gas that has adhered to the sludge. When this process is applied to the denitrification of food processing wastewater, the nitrogen in the treated water becomes less than 10~20 mg/l at the removal rate of 90~95%.

## 2. Batch-wise Anoxic-Aerobic Activated Sludge Process

This process, using single or plural aeration tanks of activated sludge, and alternately making aerobic and anoxic conditions, removes BOD, oxidizes ammonia, and denitrifies wastewater. Batch-wise systems shown in Figure 2-6-4 have the merits of a simple system, small space requirements, and easy operation and maintenance. Process A in Figure 2-6-4 is called the limited aeration process. In this process, aeration is halted and nitrification proceeds by mixing the wastewater while the inflow continues, removing 70% of the nitrogen. B is called an intermittent aeration process and, aeration (aerobic) and agitation (anoxic) are alternately performed on the wastewater. C is a process performing alternate aeration (aerobic) and agitation like B. In this process however, wastewater is fed to promote denitrification by utilizing BOD prior to mixing nitrified liquid. As the wastewater is fed a few times, the nitrogen removal rate exceeds 90%.

### 6.2.3 Method of Increasing Biomass Holding

#### 1. Biofilm Process

Nitrification bacteria do not form floc, but they grow in activated sludge floc. Media are used like with BOD removal in order to increase biomass holding. Two types of media, fixed bed and floating media, are used. The materials are resins, inorganic materials, entrapped

immobilization media made from polyethylene glycol, etc. The nitrification velocity in the biofilm process is 3 times that in the suspended sludge process. The biofilm process is applied, using the scheme shown in Figure 2-6-2 or Figure 2-6-3. Sludge management is easy because the processes do not need a settling tank. If a settling tank is provided and used for coagulation-sedimentation, then fine quality effluent can be obtained because SS and phosphorous are removed at same time in the settling tank.

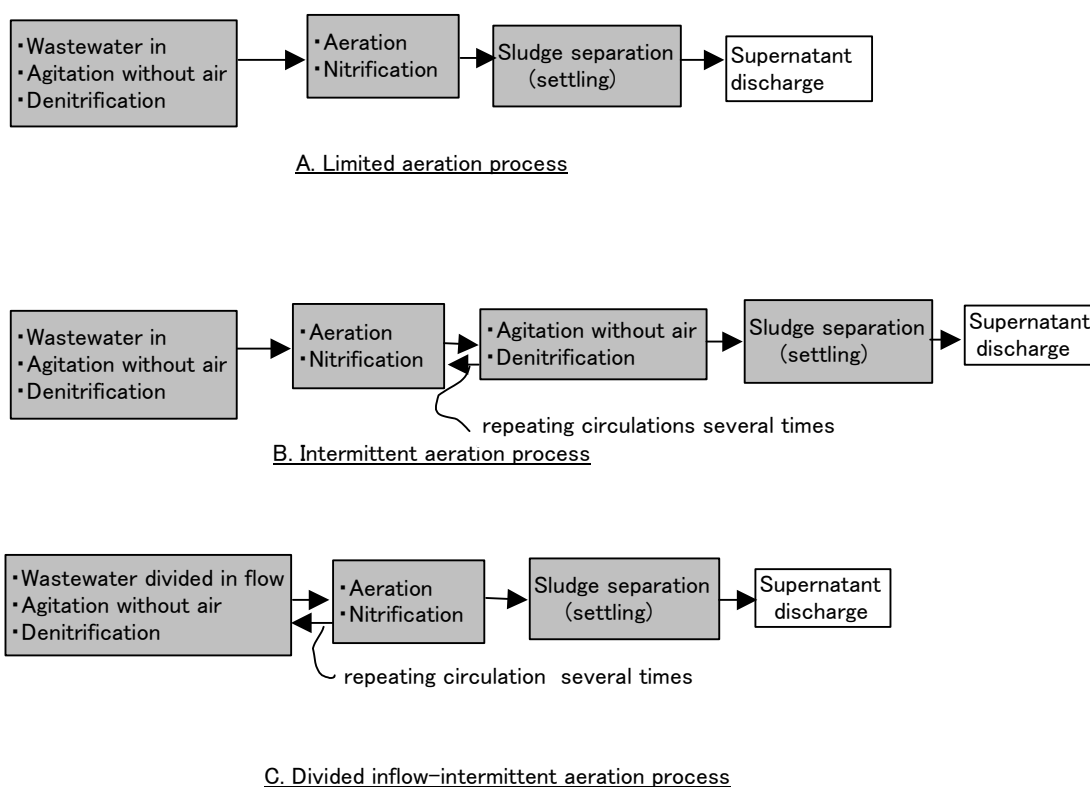

Figure 2-6-4 Batch wise anaerobic -aerobic activated sludge process

## 2. Granule Process

Denitrification bacteria are granulated to form 1~2 mm diameter pellets, and the pellets are filled into a denitrification unit as shown in Figure 2-6-5. In the unit, wastewater containing nitrate flows upward, contacts the granules, and then nitrogen gas is released by denitrification. The gas is separated at the GSS (Gas-Solid Separator) at the upper part of the unit. As granulation of the denitrification bacteria creates a bacteria concentration of up to tens of thousands mg/l, the NO<sub>3</sub>-N loading rate may be raised up to 10 kg/m<sup>3</sup> · d, which is 5~10 times when the suspended process is used, resulting in significant downsizing of the plant. Furthermore, this process can be applied to wastewater with 50~1,500 mg/l of NO<sub>3</sub>-N and achieves nitrogen removal higher than 99%.

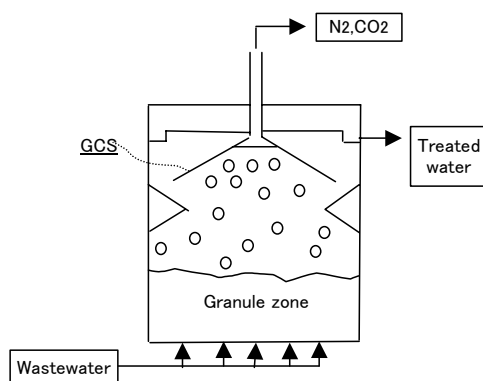

Figure 2-6-5 Denitrification unit by granule anaerobic sludge

### 6.3 Phosphorous Removal

#### 6.3.1 Phosphorous Removal Mechanism and Processes

Phosphorous is used in food industries although the quantity is small. It remains in wastewater in the form of phosphate. The quantity in the effluent from the activated sludge process depends on the ratio of BOD and phosphorous, dissolved oxygen concentration in the aeration tank, and the rate of excess sludge generation. Phosphorous in the influent is eventually transferred, to the excess sludge to be carried out and to the effluent to be discharged, out of the treatment system. There are several processes to remove phosphorous from the effluent in the activated sludge process such as the physical chemical process which changes phosphorous to insoluble phosphate by coagulation and separation from water, biological process by which activated sludge takes in excessive phosphorous, and physical process by which zirconium adsorbs phosphorous. These removal mechanisms and features are summarized in Table 2-6-2.

Table 2-6-2 Typical phosphorous removal processes

	Anaerobic, aerobic process	Coagulation-settling process	Phostripping process	Zirconium adsorption process
Removal mechanism	drainage of sludge luxuriously uptaking P in anaerobic-aerobic activated sludge process	coagulation-settling by dosing coagulants to effluent in activated sludge process	combination of anaerobic-aerobic activated sludge process and coagulation-settling	adsorption to zirconium ferrite
Advantages	<ul style="list-style-type: none"> <li>•partial remodeling of activated sludge treatment plant makes possible to remove P</li> <li>•97 % of P removal is reported by single phase sludge process-circulating nitrification-phosphorous removal process</li> </ul>	<ul style="list-style-type: none"> <li>•high removal rate</li> <li>•possible to reduce to about 0.1 mg/l (for reference)</li> </ul>	<ul style="list-style-type: none"> <li>•less coagulants requirement due to dosage of coagulants to P concentrated liquid</li> <li>•possible to reduce to about 0.5 mg/l (for reference)</li> </ul>	<ul style="list-style-type: none"> <li>•recover of P</li> <li>•possible to reduce to about 1 mg/l (for reference)</li> </ul>
Defects	•lower removal rate than physical chemical process	•chemicals cost	•increase of operating parameters	•economics

### 6.3.2 Anaerobic-Aerobic Activated Sludge Process

Under aerobic conditions, activated sludge adsorbs phosphorous into the cell as a form of polyphosphoric acid. Under anaerobic conditions, activated sludge takes in organic materials and releases phosphorous instead. Accordingly, if organic materials are fed to activated sludge under anaerobic conditions, and the condition is changed to aerobic, then the sludge takes in excessive phosphorous, and the phosphorous-luxurious-uptake-phenomenon occurs. Although normal activated sludge contains about 1.0~1.6% of phosphorous in the cell, the excessive phosphorous taken in is increased up to about 5%. The basics of biological phosphorous removal are an AO process (Anaerobic Oxidic Process) shown in Figure 2-6-6, by which about 90% of the phosphorous is taken out of the system by extracting excess sludge storing phosphorous excessively. If a denitrification tank is added to this process, phosphorous and nitrogen are removed simultaneously at about a 75% rate as shown in Figure 2-6-7. If an appropriate volume of excess sludge is extracted from the single phase “sludge process-circulating nitrification-phosphorous removal process”, then phosphorous and nitrogen are removed simultaneously at a removal rate of above 95% and 90%. The schematic flow is shown in Figure 2-6-8. As the biological removal of phosphorous can simultaneously remove nitrogen biologically, a nitrogen removal system is often quipped together with a phosphorous removal system and visa-versa.

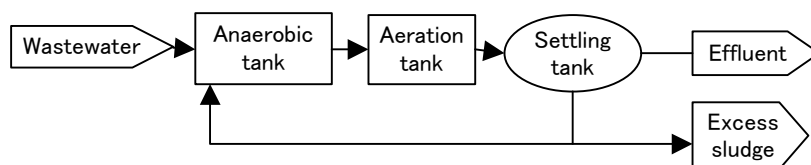

Figure 2-6-6 Basic process in biological phosphorous removal (AO process)

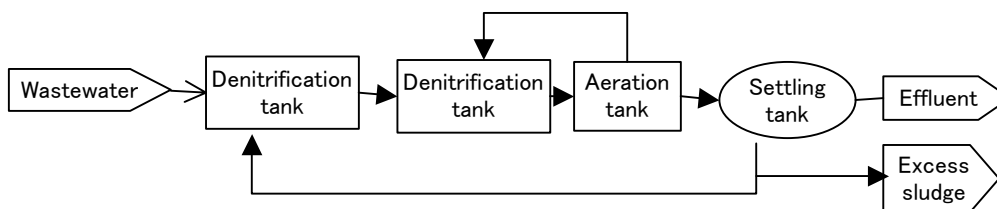

Figure 2-6-7 Biological denitrification-phosphorous removal process (A2O)

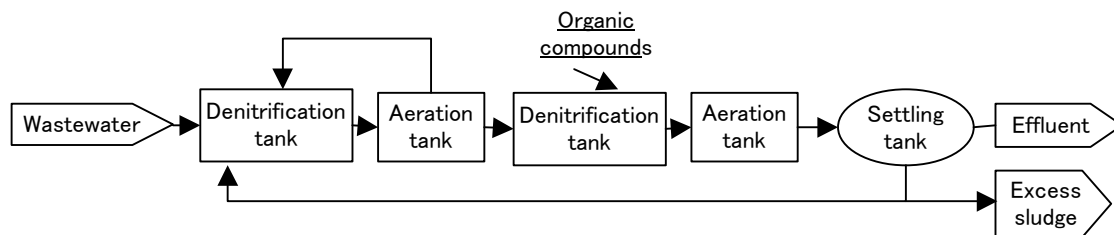

Figure 2-6-8 Single phase sludge process-circulating denitrification-phosphorous removal process

### 6.3.3 Coagulation – Settling Process

A settling non-soluble aluminum phosphate or iron phosphate is widely used to remove phosphorous from the effluent during the activated sludge process. The phosphate is used after it is changed from phosphorous and coagulated with trivalent or divalent metal compound coagulants such as aluminum sulfate, iron chloride, and iron sulfate. Coagulation is performed in the settling tank in an activated sludge process by dosing coagulants at the inlet or in the coagulation–settling tank that is set independently. Phosphorous concentration in the effluent is 0.5~several mg/l for the former process and 0.1 mg/l for the latter. The relation between the phosphorous removal rate and the required dosage of aluminum sulfate is shown in Table 2-6-3. Actually, excessive dosage is necessary, and polyelectrolytes are sometimes used to improve the coagulation anion. Since the optimum pH ranges for coagulation are 6~7 for aluminium sulfate, 4.5~5.0 for iron chloride, and around 8 for iron sulfate, pH control is occasionally necessary. If lime is added to the effluent of pH 9.5~10.0 from the activated sludge process, then non-soluble hydroxyapatite is formed. For removing phosphorous by using lime, the coagulation–sedimentation and contact-filtration processes are common. The advantages of the lime process are that salts do not increase because anion does not accumulate, unlike when using aluminum sulfate, and the polyphosphoric acid can be removed.

Table 2-6-3 Aluminum sulfate requirement for P removal

P removal rate (%)	$Al_2(SO_4)_3 \cdot 14H_2O/P$ (weight ratio)
75	13
85	16
95	22

### 6.3.4 Phostripping Process

The Phostripping Process was developed in the 1960s'. In this process, as shown in Figure 2-6-9, phosphorous adsorbed to sludge under aerobic conditions dissolves in water, under anaerobic conditions, in the phosphorous-dissolving tank. Then, dosed with coagulants, phosphorous in the supernatant is coagulated and separated by settling, while the sludge relieved of phosphorous is returned to the aeration tank.

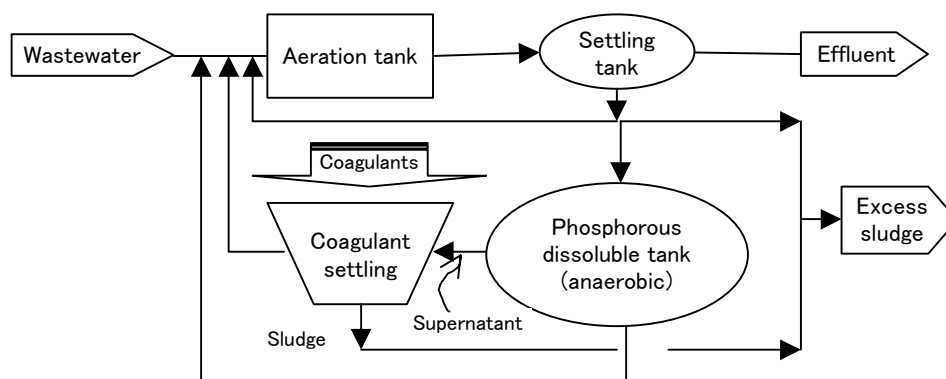

Figure 2-6-9 Phosphorous removal by phostripping process

### 6.3.5 Zirconium Adsorption Process

Granular zirconium ferrite with an ion exchange property adsorbs phosphorous in an acidic solution and releases it in an alkali solution. This process can recover phosphorous<sup>1)</sup>.

## 6.4 Color Removal

### 1. Color Removal Process

The color of the effluent from secondary treatment in food processing factories rarely causes unpleasant feelings, but sometimes the effluent is lightly colored due to the wastewater. The color comes from micron particles, byproducts, and nondegradable substances, which are generated in a biological process. When the color is attributed to micron particles or colloidal particles, it is removed by the coagulation-sedimentation process. Dissolved color ingredients are removed by ozone oxidation or activated carbon adsorption. The typical decolorizing process and features are shown in Table 2-6-4.

Table 2-6-4 Comparisons of decolorizing methods

	Coagulation-settling	Ozone oxidation	O <sub>3</sub> + UV	Activated carbon adsorption
Decolorized materials	<ul style="list-style-type: none"> <li>•micron particles</li> <li>•colloidal materials</li> <li>•some dissolved materials</li> </ul>	<ul style="list-style-type: none"> <li>•hard decomposable organic compounds</li> </ul>	<ul style="list-style-type: none"> <li>•hard decomposable organic compounds</li> </ul>	<ul style="list-style-type: none"> <li>•hard decomposable organic compounds</li> </ul>
Treatability tests	<ul style="list-style-type: none"> <li>•coagulation test</li> </ul>	<ul style="list-style-type: none"> <li>•decolorizing test</li> </ul>	<ul style="list-style-type: none"> <li>•decolorizing test</li> </ul>	<ul style="list-style-type: none"> <li>•adsorption isotherm</li> <li>•etc.</li> </ul>
Treated water	<ul style="list-style-type: none"> <li>•remains of soluble pigment ingredients</li> </ul>	<ul style="list-style-type: none"> <li>•normal</li> </ul>	<ul style="list-style-type: none"> <li>•normal</li> </ul>	<ul style="list-style-type: none"> <li>•good</li> </ul>
Construction cost	<ul style="list-style-type: none"> <li>•normal cost in case of coagulation-settling tank is only provided</li> <li>•high cost if pH adjustment is required</li> <li>•low cost if settling tank is used instead for coagulation tank, but low removal rate</li> </ul>	<ul style="list-style-type: none"> <li>•pre-treatment is usually provided to remove SS</li> <li>•high cost due to ozone generator</li> </ul>	<ul style="list-style-type: none"> <li>•higher than single ozone oxidation process</li> </ul>	<ul style="list-style-type: none"> <li>•high cost due to sand filter as pre-treatment</li> <li>•activated carbon re-generator is provided for large volume wastewater</li> </ul>
Operating cost	<ul style="list-style-type: none"> <li>•generally low</li> <li>•high if pH adjustment is required</li> </ul>	<ul style="list-style-type: none"> <li>•high, depending on grade of decolorizing</li> </ul>	<ul style="list-style-type: none"> <li>•high, depending on grade of decolorizing</li> </ul>	<ul style="list-style-type: none"> <li>•high, depending on adsorption capacity of activated carbon</li> </ul>
Space	<ul style="list-style-type: none"> <li>•relatively large</li> </ul>	<ul style="list-style-type: none"> <li>•small</li> </ul>	<ul style="list-style-type: none"> <li>•small</li> </ul>	<ul style="list-style-type: none"> <li>•normal</li> </ul>
Others	<ul style="list-style-type: none"> <li>•sludge generation</li> <li>•increase of operating parameters</li> </ul>	<ul style="list-style-type: none"> <li>•reduction of COD, BOD</li> <li>•disinfection</li> <li>•easy operation</li> </ul>	<ul style="list-style-type: none"> <li>•reduction of COD, BOD</li> <li>•disinfection</li> <li>•maintenance of UV</li> </ul>	<ul style="list-style-type: none"> <li>•reduction of COD, BOD</li> <li>•disinfection</li> <li>•increase of operating parameters</li> </ul>

## 2. Coagulation-Sedimentation Process

This process is most widely used, and the mechanism is the same as the process for SS removal. In the decolorizing process, coagulants and pH in reaction should be selected to make the process effective and economical, considering the influence of surface electro potential relating to the hydrophilicity and hydrophobicity of the remaining micro particles as well as the influence of the isoelectric point (usually around pH 5) of the remaining protein particles.

## 3. Ozone Oxidation Process

Ozone is a powerful oxidizing agent next to fluorine and is used for disinfection, decolorizing, deodorizing, and oxidation of the remaining trace organic compounds in water. Ozone is industrially generated from air or oxygen rich air from silent discharge in high-voltage electrical fields. To improve the efficiency of decolorizing, various means are contrived in designing gas-liquid contact equipment such as fine ozone bubbles generation, gas-liquid mixing by agitation, and counter current contact. As the decolorizing reaction proceeds, the reaction time tends to become longer, the ozone utilization rate tends to be lowered, and the economic merits tend to be lost rapidly.



#### 4. Ozone plus UV Oxidation

This process is to decompose organic matter by combining ozone with hydrogen peroxide or ozone with UV radiation. Comparing it to the ozone only process, the ozone plus UV process accelerates the oxidation of organic compounds because UV promotes decomposing the ozone and generating OH radicals with their strong oxidation power being enhanced. The process was developed originally for decomposing cyanide compounds, and the applications are limited to specific fields such as decomposing traces remaining of hardly-decomposable organic compounds, due to the high equipment and operation costs.

#### 5. Activated Carbon Adsorption Process

Generally, organic compounds can be removed by either powder activated carbon or granulated activated carbon, but granulated activated carbon is mainly used for treating wastewater. Granulated activated carbon is made of coal or coconut shell and is classified into formed carbon, powder carbon, etc. from the shape. As the decolorizing test result is closely similar to Freundlich's adsorption isotherm, the viability of the activated carbon adsorption process is judged by the slope of the adsorption velocity. In activated carbon absorbers, there are the fixed bed type (batch-wise operation), fluidized bed type (continuous operation), and moving bed type (continuous operation). For regenerating spent activated carbon, there are on-site and off-site methods. Water qualities for the boilers are set forth by JIS.

#### **6.5 Reusing Treated Water**

In food factories, water is used for raw materials, product treatment/rinsing, boilers, cooling, cleaning floors/cars, scenic purposes, watering plants, toilet flushing, etc. Required water qualities for raw material and product treatment/rinsing vary in accordance with products, and there are individually set standards. Cooling water qualities are not strictly standardized, but boiler standards are correspondingly applied to cooling use. For cleaning floors/cars, reused water shall be disinfected and desalinized to avoid the risk of product contamination. The main economical points for reuse in food factories are watering plants and flushing toilets. Though effluent water quality from tertiary treatment is sufficient for these purposes, disinfection is desirable for hygienic reasons, and countermeasures against offensive smells, colors, and foaming should be considered. Table 2-6-5 shows the reuse points, treatment methods, and water qualities.

Table 2-6-5 Reusing treated water and water quality

Reuse	Water sprinkling, flushing toilet <sup>2)</sup>	Holding communion with water, scenery use <sup>2)</sup>	Water qualities for industrial water
Treatment method	Coagulation-settling + sand filter + UF filtration	Coagulation-settling + sand filter + UF filtration + O <sub>3</sub> + activated carbon adsorption + UF filtration	
Coli form number(No./m <sub>l</sub> )	<10	<0.5	<1 <sup>※1</sup>
Residual Cl <sub>2</sub> (mg/ℓ)	>0.4	-	>0.1 <sup>※2</sup>
Turbidity (degree)	-	<10	<20
pH	5.8~8.6	5.8~8.6	6.5~8.0
Volatile residual solids(mg/ℓ)	-	-	<250
Alkalinity (CaCO <sub>3</sub> )(mg/ℓ)	-	-	<75
Hardness (mg/ℓ)	-	-	<120
Chlorine ion (mg/ℓ)	-	-	<80
Color (degree)	40	10	2~80 <sup>※3</sup> 5~10 <sup>※4</sup>
BOD(mg/ℓ)	<20	<10	-
COD(mg/ℓ)	<30	-	-

Remarks ※1 Public bath standard ※2 Tap water standards ※3 Permissible water quality for boiler water  
 ※4 Permissible general water quality for food industry

REFERENCES

- 1) Takai, T. et al. Phosphorous Recovery and Recycle Technology, *The Best Treatment of Food Processing Wastewater Handbook*, p. 260 (Science Forum, 2002).
- 2) Kawabata, M. Water Recycle Technology, *The Best Treatment of Food Processing Wastewater Handbook*, p. 253 (Science Forum, 2002).

**Chapter 7 Sludge Treatment and Volume Reduction**

Excess sludge treatment and disposal costs in food processing industries share about 70% of the total operating cost in wastewater treatment plants, and cost savings are urgently demanded. The sludge generated in wastewater treatment is usually dewatered by dehydrator and carried out of the plant. In plants it is dried and turned to fertilizer or incinerated to be taken out as ash, reduced in volume. There are various types of dehydrators and coagulants for the different properties of the sludge and dehydrators. Some plants have introduced a new process that drastically reduces sludge volume in order to eliminate outside disposal, and an increasing number of plants are adopting it.

## 7.1 Dehydration

### 7.1.1 Sludge Coagulation

In order to effectively squeeze water out of sludge under pressurized dehydration, the sludge is dosed with coagulants to make strongly flocculated sludge that prevents leaking micro particles and clogging filter cloth. Two types of coagulants, inorganic coagulants shown in Table 2-7-1 and polyelectrolytes shown in Table 2-7-2, are used. Bentonite, a coagulant aid, is rarely used now, because it increases sludge volume and polyelectrolytes have been developed to occupy the major position of coagulant aid. The surface of organic sludge is generally charged negatively causing repulsion among particles and dispersing them. Cationic inorganic coagulants are often used to coagulate particles by neutralizing the surface electric charge. Polyelectrolytes promote the formation and stabilization of floc by neutralizing, bridging, and binding floc. Optimum dosage and pH are to be studied by testing a number of coagulants and coagulant aids in order to achieve effective dehydration. The PRTR (Pollutant Release and Transfer Register) law enacted in 2001 in Japan lays out the procedures for reporting and making public the chemical substances released into the environment and transferred in the waste. When coagulants are purchased, their safety shall be confirmed by MSDS (Material Safety Data Sheet).

Table 2-7-1 Typical inorganic coagulants for dehydration

Coagulants	Molecular formula
Aluminum sulfate	$\text{Al}_2(\text{SO}_4)_3 \cdot 18\text{H}_2\text{O}$
Ferric chloride	$\text{FeCl}_3 \cdot 6\text{H}_2\text{O}$
Polyaluminum chloride	$[\text{Al}_2(\text{OH})_n\text{Cl}_{6-n}]_m$
Calcium hydroxide	$\text{Ca}(\text{OH})_2$

Table 2-7-2 Typical polyelectrolyte for dehydration

Cationic polyelectrolyte	polyethyleneimine, polymethacrylic acid ester,
Anionic polyelectrolyte	sodium polyacrylic acid, polyacrylamido
Nonionic polyelectrolyte	polyacrylamido, polyoxyethylene

### 7.1.2 Dehydrator

Sludge is dewatered mechanically and/or naturally. The natural process is used for drying small volumes of sludge by using a drying bed or dewatering bag within limited applicable conditions, because of the wide space required and emission of disagreeable smells. Various types of mechanical dehydrators, shown in Table 2-7-3, are widely used because they

can reduce the sludge volume using small space. Various types of dehydrators are on the market to meet various needs due to different properties of sludge and available space. The different features are as follow below:

Table 2-7-3 Typical dehydrators and features

Dehydrators	Belt press	Centrifuge	Filter press	Vacuum filter	Screw press
Dewatering rate	○	△	◎	▲	◎
Recovery of SS	△	○	○	◎	▲
Initial cost	◎	△	▲	○	▲
Operating cost	◎	▲	○	△	△
Space	○	◎	▲	▲	△
Maintenances	○	◎	△	○	○
Working environment	△	◎	△	▲	◎

Remarks: Though appraisals vary in site conditions and econometrics, these are evaluated for general uses; ◎excellent, ○good, △normal, ▲some disadvantages

### 1. Belt Press Dehydrator

The belt press dehydrator is composed of two woven-cloth filter belts, a rubber belt, rollers, belt traveling adjustment devices, driving units, etc. a shown in Figure 2-7-1. Sludge flocculated by coagulants is fed to the upper surface of the lower filter cloth, dehydrated by gravity, moved into the opening of the two filter cloths, pressurized gradually in the high pressure zone, and then dewatered again. The rollers and rubber belts press the sludge. Sludge coming out of the high-pressure zone is separated from the belts by a scraper knife. Filter cloths are washed with high pressure water to prevent the filter cloths from clogging. The water content in the dewatered sludge is thought to be the second lowest after the filter press, but the process consumes much water for washing the filter cloths.

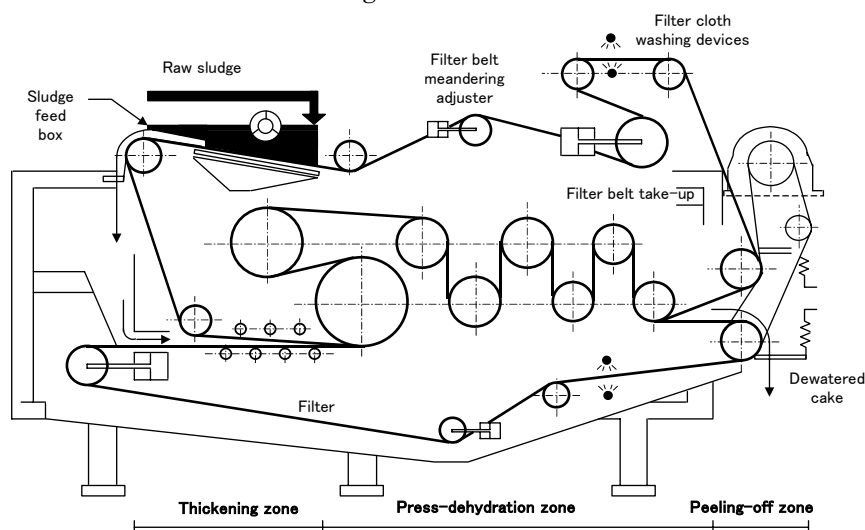

Figure 2-7-1 Belt press dehydrator

## 2. Centrifuge

Each centrifuge used for sludge dehydration is composed of a rotating outer bowl and an inner screw as shown in Figure 2-7-2. Sludge is pressed on the inner surface of the outer bowl by a centrifugal force of 1,000 ~ 2,000 G at high speed revolution, transported in one direction by the screw owing to the slight differential speed between the outer bowl and the screw, and moved up along the inner surface of the tapered end from where the dewatered cake is discharged. The water level in the centrifuge is adjusted by the position of the liquid outlet weir. As strong force is applied to the sludge, a higher SS recovery rate is obtained by using polyelectrolytes with strong coagulation force. As centrifuge dehydration is achieved by utilizing the density differences between floc and water, water content remaining in the cake from food processing factories where sludge contains a higher ratio of organic materials is higher than the cakes dewatered by other dehydrators. Still, the advantages of small space requirements and cleanness for job sites make the process widely acceptable in food factories.

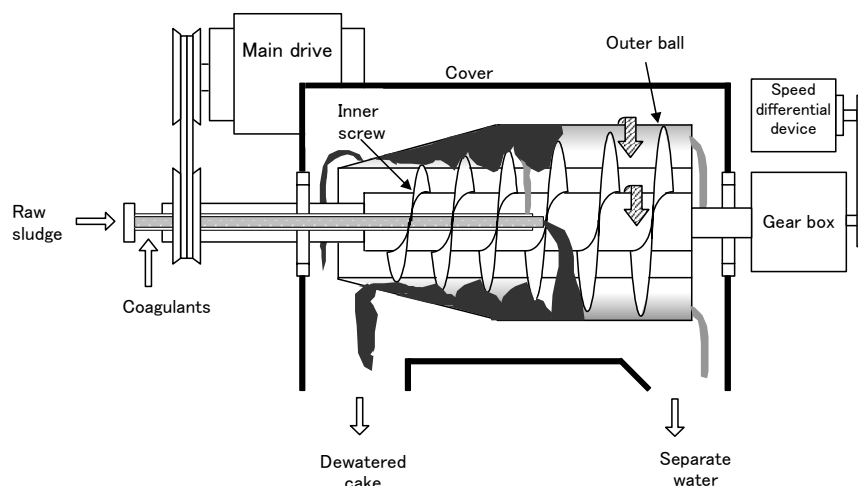

Figure 2-7-2 Centrifuge dehydrator

## 3. Filter Press

The filter press is the oldest dehydration process. Though fully automated now, it is a batch operation system in principle. As the sludge in the plate frames are pressed by the diaphragm, water is squeezed out through the filter cloths as illustrated in Figure 2-7-3. After squeezing, the plate frames are opened, dewatered sludge cake falls down, and then the filter cloths are washed by high-pressure water. To achieve effective dehydration, dehydration tests are made to select the appropriate filter cloth and combination of pressure range / filtration velocity / time sequences / coagulants. The water content in cake dewatered by filter press is

normally lower, and the SS recovery rate is relatively higher than that of other dehydration processes.

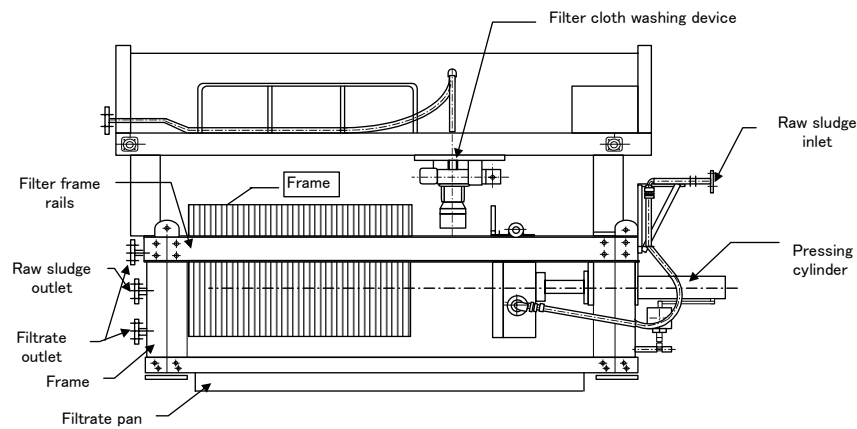

Figure 2-7-3 Filter press dehydrator

#### 4. Vacuum Filter

As illustrated in Figure 2-7-4, the vacuum filter is composed of a rotating drum covered by a filter cloth and a sludge tank at the underside of the drum. The inside of the drum is kept at a slightly lower pressure (light vacuum) than outside. The sludge is sucked, attached to cover the surface of the filter cloth, dehydrated, and scraped off. After scraping, the filter cloth is washed by jet water. The dehydration rate is lower than other dehydrators due to the small pressure differences. Modifications like a belt-press type mechanism and improved scraping mechanism for the filter have been added. Inorganic coagulants are preferably used. A high volume of water is used for filter cloth washing to avoid clogging. The SS recovery rate is relatively low.

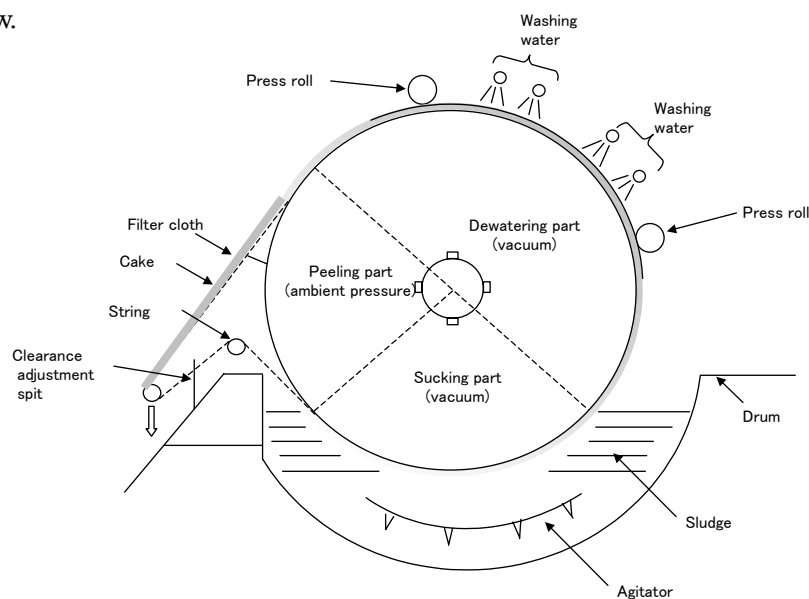

Figure 2-7-4 Vacuum filter dehydrator

## 5. Screw Press Dehydrator

As shown in Figure 2-7-5, the screw press dehydrator is composed of a horizontally-laid metallic drum, the downside of which is perforated, and a tapered screw rotating at low speed inside the drum. Flocculated sludge fed into the drum is pushed forward slowly by the rotating screw, and squeezing is gradually strengthened as the screw is taper-shaped. As the perforation size is relatively large, the selection of coagulants and the coagulation condition form strong floc, strong enough so that break-up and leakage do not occur. The moisture content in the cake can be adjusted by the opening of the scraper at the dewatered cake exit.

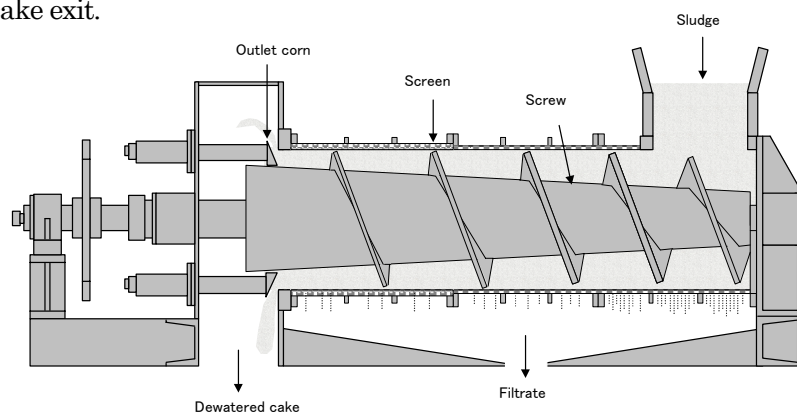

Figure 2-7-5 Screw press dehydrator

## 7.2 Drying

Dehydrated sludge still contains 75~90% water and, if left alone, it tends to rot and smell offensive. When dehydrated sludge is used as fertilizer, it is shaped into dry pellets for easy spraying and storage. Fertilizer made from food factory sludge should comply with the Fertilizer Control Law and satisfy the Recommendation Standards issued by the Organic Fertilizer Quality Preservation Study Group (see Table 2-7-4). Dryers used for sludge drying are classified as rotary, vertical multistage, fluid bed, flash, and other types. In food factories, the rotary dryers are generally used, and vertical multistage dryers are used for large facilities.

### 1. Rotary Type

The rotary dryer is composed of a rotating drum, agitating blades in the rotating drum (used for moving sludge), hot air blower, cyclone, and deodorizer as shown in Figure 2-7-6. Dehydrated sludge on the drum wall is lifted up by the rotation, falls down making continuous contact with hot air, and is then discharged from the exit, with less than 10% water content. The hot air is cooled down from about 700 °C to 120 °C and is released into the air after the

dust is removed. Two types, parallel flow and countercurrent flow, which are named after the directions of the sludge and hot air, are used.

Table 2-7-4 Organic fertilizers standards recommended by Organic Fertilizer Quality Preservation Study Group

Common quality standards	1. to meet permissible concentrations of arsenic, cadmium and mercury stipulated in guidelines for special fertilizers in accordance with Fertilizer Control Law (arsenic <50 ppm, cadmium <5 ppm and mercury <2 ppm) 2. detection of no sign of abnormal growth in plants. It is desirable to confirm it by young plant (pervidis) 3. copper and zinc contents in dry fertilizers are less than 600 ppm and 800 ppm respectively			
Specified standards for sludge	Indication	Standard items	Standards for sludge of food processing industry	
	Quality indication is required	organic materials (dry base) C/N N contents (dry base) PO <sub>3</sub> contents (dry base) alkalinity (dry base)	Compost	Sludge
			> 40 % < 10 > 2.5 % > 2 % < 25 %	> 50 % < 10 > 2.5 % > 2 % < 25 %
Quality indication is not required	water (dry base) pH (as products)	< 50 % < 8.5	< 30 % -	

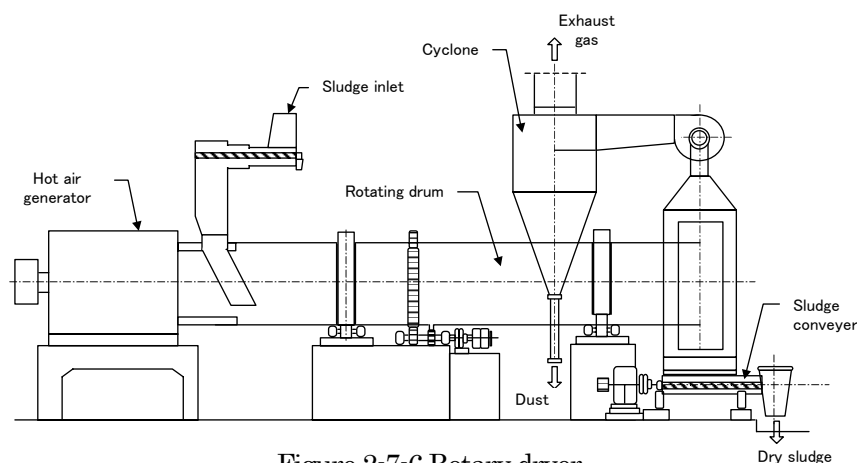

Figure 2-7-6 Rotary dryer

## 2. Vertical Multistage Type

Dehydrated sludge is thrown in from the top of the furnace and moved downward stage by stage. At each stage, the sludge is raked horizontally with the blades fixed to the rotating axis and moved to the next stage through holes, while being dried by hot air blown in from the burner. The structure is shown schematically in Figure 2-7-7.



### 7.3 Incineration

Sludge incineration aims at reducing sludge volume and making it hygienically safe and stable. Incinerators are almost the same as dryers in system and structure. Incineration temperature varies by furnace type with a range of 700~1,000 °C, and the inner parts are insulated by refractory materials to handle the high temperatures.

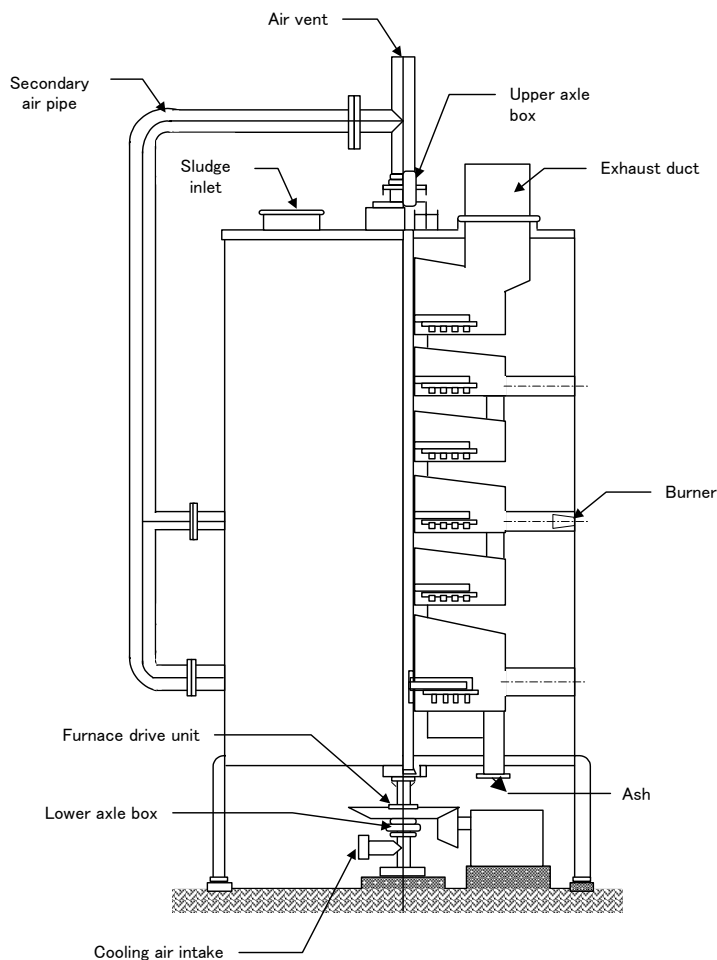

Figure 2-7-7 Multi-stage vertical dryer

### 7.4 Composting

One effective sludge uses is as fertilizer through composting. When composting is planned, judgment based on comprehensive evaluation of securing distribution and sale channels as well as issues related to storage and operability of spraying is needed. Sludge containing harmful materials and/or heavy metals cannot be used as fertilizer.

## 1. Composting

Compost is a product of aerobic fermentation by aerobic microbes. Composting is accelerated by creating appropriate environmental conditions for these bacteria, which are moisture in sludge, temperature, oxygen, C/N ratio, etc. As the optimum moisture contents for starting composting are 40~60%, part of the ready-made compost is returned to dehydrated sludge containing 80~90% moisture for adjustment in the beginning. An effective way of adjusting the C/N ratio and moisture contents is mixing sludge with solid waste such as raw materials or off-spec-products from food factories. Sludge with adjusted moisture continues fermentation under mechanical plowing for 10 to 20 days in the fermentation chamber. Temperature reaches 70~80 °C at maximum during fermentation. The fermentation heat evaporates much of the water in the sludge and kills the pathogens. After first stage fermentation, the sludge matures, changes to humus under microaerophilic condition, and dries further for 1 to 3 months.

## 2. Composter

There are two types of composters. One is the flat arrangement type and the other is the vertical arrangement type. The vertical arrangement type can save space. An example of a vertical type composter is shown in Figure 2-7-8.

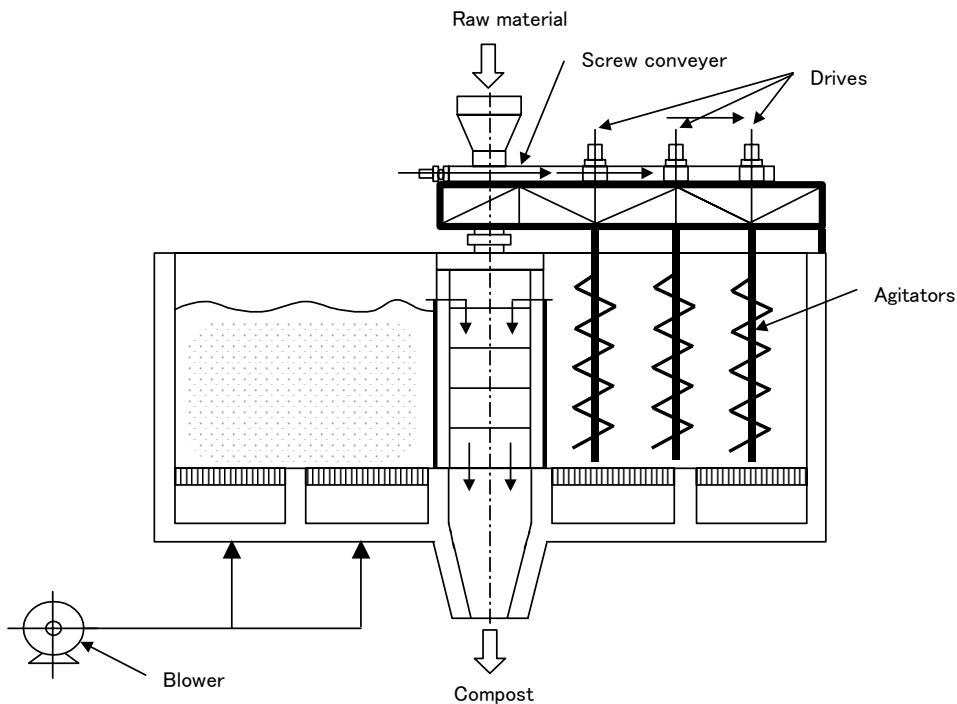

Figure 2-7-8 Vertical type composting unit

## 7.5 Sludge Reduction Process

Most excess sludge generated in biological wastewater treatment is disposed of at industrial waste landfill sites after reducing the volume by dehydration or incineration following dehydration. As landfill sites are decreasing year by year, however, the disposal cost is rising. The sludge reduction processes using thermophilic bacteria and ozone have been developed so they can be used, and biological processing without sludge generation is beginning to be carried out.

### 1. Thermophilic Sludge Digestion Process<sup>1)</sup>

A schematic flow of the thermophilic sludge digestion process is shown in Figure 2-7-9. Excess sludge is fed to the thermophilic sludge digester kept at 65 °C, solubilized by thermophilic bacteria enzymes, and then returned to the aeration tank. Solubilized sludge is eaten by activated sludge and converted to carbon dioxide and water. Table 2-7-5 and Figure 2-7-10 show the relation of the circulation ratio of excess sludge to effluent quality and to excess sludge generation. If three times the volume of the excess sludge is circulated in the thermophilic sludge digester and solubilized, judging from these figures, the excess sludge generation can be reduced to almost zero. When this process is introduced to the existing activated sludge process, the oxygen supply should be increased because it overweighs the load in the aeration tank.

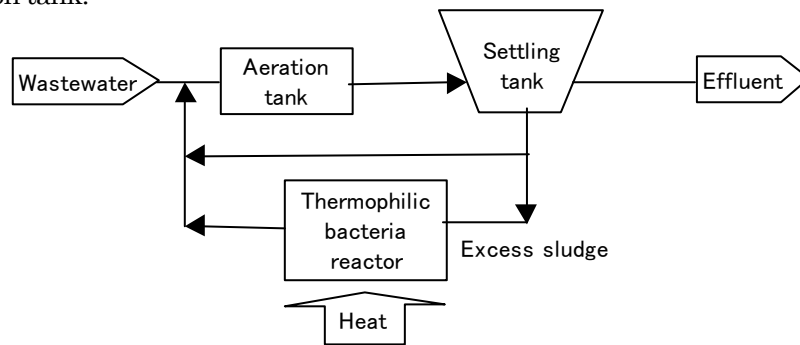

Figure 2-7-9 Sludge reduction process by thermophilic bacteria

Table 2-7-5 Operating conditions of thermophilic bacteria reactor and effluent quality

Run	1	2	3	4	5
Aeration tank load (kg TOC/kg VSS/d)	0.15	0.17	0.19	0.21	0.15
MLVSS (mg/ρ)	2,000	1,800	1,800	1,800	2,400
Thermophilic bacteria reactor (°C)	65	–	–	–	–
Sludge circulation rate (Q <sub>s</sub> /Q <sub>w</sub> )	0	1	2	3	4
Effluent S-BOD (mg/ρ)	<5	<5	<5	<5	<5
SS (mg/ρ)	21	21	23	23	22

Q<sub>s</sub>: returning sludge volume to thermophilic bacteria reactor, Q<sub>w</sub>: Excess sludge generated in activated sludge process

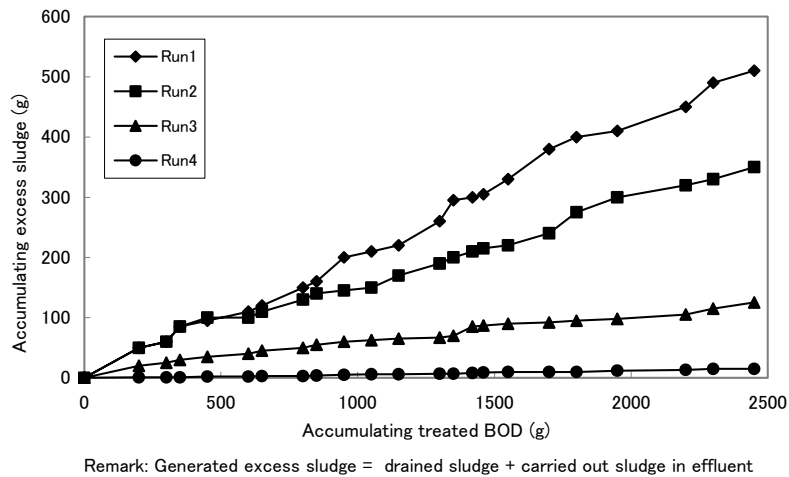

Figure 2-7-10 Excess sludge generation versus sludge returning ratio

## 2. Sludge Reduction Process by Ozonation<sup>2)</sup>

The sludge reduction process using ozone is shown in Figure 2-7-11. Excess sludge is transported to the ozonation tank, solubilized, and returned to the aeration tank again. The pH in the ozonation tank is acidified to enhance the reaction of the ozone, and the solubilized sludge is neutralized before returning it to the aeration tank. The solubilized sludge is eaten by micro-organisms and converted to carbon dioxide and water. If 3 to 4 times the volume of the excess sludge is circulated in the ozonation reactor and solubilized, the excess sludge generation can be reduced to almost zero. When this process is introduced to the existing activated sludge process, oxygen supply should be increased because it overweighs the load in the aeration tank.

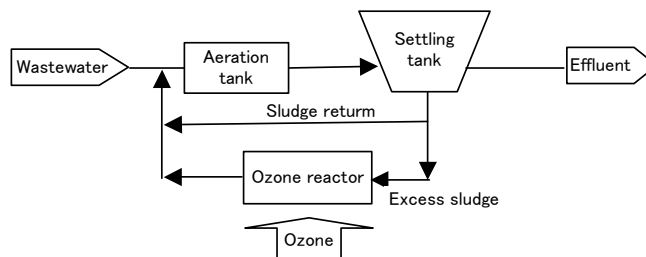

Figure 2-7-11 Sludge reduction process by ozone

## REFERENCES

- 1) Akashi, A. et al. Sludge Reduction Process by Thermophilic Bacteria, *The Best Treatment of Food Processing Wastewater Handbook*, p 156 (Science Forum, 2002).
- 2) Nishimura, S. Sludge Reduction Process by Ozone, *The Best Treatment of Food Processing Wastewater Handbook*, p 165 (Science Forum, 2002).

## Chapter 8 Control and Measure in Plant Operation

### 8.1 Aerobic Biological Treatment

Different methods of positioning biomass are used in aerobic biological treatment. One is the method of suspending biomass like the activated sludge process and the others are the methods of fixing biomass on floating media or contactors like biofilm. Accordingly, there are differences between the equipment used. Consequently, control and maintenance items in plant operation vary. Common items in aerobic biological processes are described here.

#### 1. Normal BOD Loading

The relation between the BOD-MLSS load (BOD kg/MLSS kg · d) in the activated sludge process and effluent quality varies due to the temperatures in the aeration tank and the process in food factories usually being operated at less than 0.4 (BOD kg/ MLSS kg · d). MLSS in an aeration tank is generally kept between 3000~5000 mg/ℓ. As for measures to cope with long-term fluctuations of influent loads; when the BOD load is high, the BOD-MLSS load can be adjusted by increasing the MLSS concentration. When the BOD load is low, the BOD-MLSS load can be adjusted by decreasing the MLSS concentration. When the temperatures are lower in the winter, the decreased reaction speed is compensated for by increasing the MLSS concentration. Therefore, for higher temperatures in summer, the MLSS concentration is decreased. As the BOD-MLSS load decreases, the volume of generated excess sludge decreases owing to the endogenous phase progress in sludge. Controlling MLSS concentration in aeration tanks at appropriate levels is important because of these mechanisms. For sludge concentration management taking account of seasonal fluctuation for the long term and for maximizing the function of the equalization tank for daily loads, it is necessary to prepare a load control manual reflecting operation data kept in good order and analyzed well.

#### 2. Sedimentation and Separation of Sludge

Problems in sedimentation and separation in the activated sludge process are summarized in Table 2-8-1<sup>1)</sup>. Most of the problems in sludge sedimentation and separation are solved by properly adjusting the BOD-MLSS load under appropriate sludge management as mentioned before. The most serious problem in the activated sludge process is sludge bulking. The causes of sludge bulking originating in the wastewater are a high concentration of low molecular compounds like saccharide; high concentration of reduced sulfur; shortage of nutrients

Table 2-8-1 Obstacles of activated sludge settling and separation

Obstacles in solids/liquid separation		Appearances	Causes	Measures
Cloudy	Dispersing	<ul style="list-style-type: none"> <li>• No clear surface of settling sludge</li> <li>• Small flocs</li> <li>• Suspension state</li> </ul>	<ul style="list-style-type: none"> <li>• Influent of high concentration organic materials</li> <li>• Shortage of MLSS</li> </ul>	<ul style="list-style-type: none"> <li>• Lowering load in aeration tank</li> </ul>
	Solubilizing	<ul style="list-style-type: none"> <li>• Cloudy in supernatant</li> <li>• Lower transparency</li> </ul>	<ul style="list-style-type: none"> <li>• Over aeration at low aeration load</li> <li>• Abnormal growth of macro biology</li> <li>• Influent of hazardous materials</li> </ul>	<ul style="list-style-type: none"> <li>• Lowering MLSS</li> <li>• Reducing aeration</li> <li>• Elimination of hazardous materials</li> </ul>
Scum generation		<ul style="list-style-type: none"> <li>• Sticky brown froth</li> </ul>	<ul style="list-style-type: none"> <li>• Abnormal growth of actinomyces and true fungi</li> </ul>	<ul style="list-style-type: none"> <li>• Shorten of SRT</li> <li>• Disinfection</li> </ul>
Sludge mass flotation in settling tank		<ul style="list-style-type: none"> <li>• Sludge mass floating</li> </ul>	<ul style="list-style-type: none"> <li>• Excess nitrification</li> <li>• Bubbles adhering to sludge</li> </ul>	<ul style="list-style-type: none"> <li>• Reducing aeration</li> <li>• Lowering MLSS</li> </ul>
Bulking	Filamentous	<ul style="list-style-type: none"> <li>• Increase of SVI</li> <li>• Clear surface of settling sludge</li> </ul>	<ul style="list-style-type: none"> <li>• Low load</li> <li>• Low DO</li> </ul>	<ul style="list-style-type: none"> <li>• Reducing aeration</li> <li>• Lowering MLSS</li> <li>• Providing anaerobic zone</li> <li>• Divided wastewater inflow to aeration tank</li> </ul>
	Non filamentous	<ul style="list-style-type: none"> <li>• Clear supernatant</li> <li>• Increase of sludge viscosity</li> <li>• Foaming</li> </ul>	<ul style="list-style-type: none"> <li>• High load operation</li> </ul>	<ul style="list-style-type: none"> <li>• Increasing MLSS</li> <li>• Adjustment of load to aeration tank</li> </ul>

such as N, P, and Fe; and influent with toxic materials. The causes attributing to originating from operations are lower loading operations ( $<0.2 \text{ BOD kg/MLSS kg} \cdot \text{d}$ ), higher loading operations ( $>0.4 \text{ BOD kg/MLSS kg} \cdot \text{d}$ ), low DO concentrations ( $<0.2 \text{ mg/l}$ ), abnormal pH (significant deviation from the range of 6.5 to 8.0), and short sludge retention times. When sludge bulking occurs, settleability is resumed by solving these problems. Emergency measures are dosing heavy additives such as lime and bentonite, and dosing bulking inhibitors. As bulking sludge keeps a high coagulation force from even losing compaction, dosing coagulants is generally not that effective. It may even worsen the bulking because aluminum contained in coagulants adversely affects the respiration activity of the activated sludge, or a shortage of phosphorus is caused by the coagulation. Though a dosage of coagulants in the settling tank is temporally effective, repeated circulation between the settling tank and aeration tank will deteriorate the sludge's coagulation, and the dosage will have to be increased gradually. If sludge bulking is chronic, then modification of the process shall be made in several ways which include introducing a plug-flow with gradient BOD concentration in the aeration tank; adopting batch-wise operation; introducing anaerobic digestion as pre-treatment and incorporating a biological phosphorous removal process and denitrification process; and a sludge reduction process using thermophilic

bacteria or ozone. These methods aim at controlling the activity of aerobic sludge bulking bacteria by incorporating anaerobic operations into the aerobic process. The method of introducing anaerobic digestion as pre-treatment and incorporating a biological phosphorous removal process and denitrification process as well as that of a sludge reduction process using thermophilic bacteria or ozone are achieved together with energy recovery and sludge reduction.

### 3. Dissolved Oxygen

The concentration level at which the oxygen concentration in the aeration tank is the ruling factor for the rate of biological reaction varies according to the affinity of the activated sludge to substrates, and it is estimated at 0.5 mg/l. Over-aeration accelerates nitrification and causes, by denitrified nitrogen gas, sludge floating in the settling tank, as well as dispersing the sludge leading to deterioration of the effluent quality. These phenomenon are not direct results from the high concentration of dissolved oxygen, but are caused by a low BOD-MLSS load. Therefore dissolved oxygen level in the range from 0.5~2 mg/l in an aeration tank is sufficient. The optimum DO level shall be determined on the basis of past operating data including problems such as sludge bulking.

### 4. pH

pH in the aeration tank affects the action of the enzymes in the activated sludge. The optimum pH for activated sludge is normally in the range of 6~8 and deviation from this range causes deterioration. In wastewater treatment, in food processing factories the pH sometimes rises due to alkaline detergent, but it is neutralized by the bicarbonate which is produced in the reaction of carbon dioxide generated by the metabolism with carbonate and hydroxide. Low pH due to organic acids in wastewater is increased after acids are decomposed, and generated carbon dioxide is stripped out by aeration. Base anhydride created by oxidization of organic acids bases, reacting with carbon dioxide, produces bicarbonate which acts as a stable buffer, and then stabilizes the water at pH 8<sup>2)</sup>. Therefore, in the case of food wastewater treatment, the pH in an aeration tank is generally kept in the range of 6.6 ~8 without any pH adjustment, suitable for the activated sludge process.

### 5. Temperature

Temperature affects reaction velocities in biochemical reactions. The relationships

between temperature and reaction velocity are predicted from experiments, and the velocity roughly doubles for each 10 °C increase in temperature (see Part II, Chapter 5, 5-1-1). Controlling the aeration tank temperature for seasonal fluctuations bears heavily on operation costs. The performance is generally secured by adjusting the MLSS concentration to optimize the BOD-MLSS load. For instance, the MLSS concentration should be increased to compensate for the decline of reaction velocity due to the low temperatures in winter, and it should be decreased to avoid oxygen shortages due to activating endogenous respiration in summer. When these adjustments cannot handle the performance deterioration, heating or cooling is required. Maintaining the temperature range for the activated sludge depends on the reaction parameters such as the substrates, DO concentration, and pH. The activated sludge process is stably operated at around 5 °C in cold area and at around 40 °C at the highest without any problems.

## 6. Nutrients

Analysis of the bacteria ingredient shows that activated sludge requires the nutrients BOD, nitrogen, and phosphorus at the ratio of BOD: N: P=100: 5:1. In food processing wastewater, generally nitrogen is enough, but the phosphorous is insufficient.

## 8.2 Anaerobic Biological Treatment

### 1. Methane Fermentation

The methods by which biomass is held in anaerobic biological reactors are different. They are suspended in water, UASB, and fixed media. Items for control and measures for solving problems are summarized in Table 2-8-2. Though the anaerobic process is stable for loading fluctuation, when it is operated incorrectly, deviates far from the design condition, and normal performance stops, a long time is needed for recovery. Operation data shall be kept in good order, analyzed well, and used to prepare a control manual, as in the case of the aerobic process. Operation for both long-term and daily use will be greatly facilitated by such a manual.

### 2. Denitrification<sup>3)</sup>

Denitrification is a successive process of nitrification and denitrification. Nitrification proceeds slower than denitrification and is sensitive to pH, temperature, DO, and other factors. Therefore, attention during operation is focused on nitrification. For example, as DO falling



Table 2-8-2 Major managing items, problems and measures in anaerobic treatment

Control items	Control levels	Measures
Temperature in anaerobic reactor	30~39 °C	•lowering temperature for energy saving at off-operation
pH	6.5~7.5	•neutralization by alkaline •if neutralization effect is poor, load shall be reduced
Organic acids <sup>6)</sup>	effluent qualities start to deteriorate gradually when VFA exceeds more than 200~300 mg/ℓ	•lowering load
ORO <sup>7)</sup>	-100~ -400 mV	•securing of anaerobic conditions
Gas generation	0.35 Nm <sup>3</sup> /kg removed TOC •total gas volume decrease at high pH •methane concentration increase at lower pH	•load adjustment •temperature and pH adjustment
Hazardous materials inflow	references figures <sup>4)</sup> (dependency on conditions) Mg <sup>++</sup> 1,900mg/ℓ Ca <sup>++</sup> 4,800mg/ℓ K <sup>+</sup> 4,800mg/ℓ Na <sup>+</sup> 7,400mg/ℓ NH <sub>4</sub> -N 5,000~7,000mg/ℓ (as actual record) SO <sub>4</sub> <sup>-</sup> COD/SO <sub>4</sub> >7.5~20	•increase pH •Settlement of sulfide by ferric chloride •alternation of neutralizing agent NaOH→Mg(OH) <sub>2</sub>
Sludge carry-over (UASB)	granular sludge carry -over	•pH neutralization by alkalinity under plug-flow •reducing circulation
Clogging with sludge <sup>5)</sup> (fixed bed reactor)	void volume rate: 60~85 %	•scouring by nitrogen gas purging (1~2 /year)

down to 0.5 mg/ℓ limits further nitrification, the DO should be maintained so that it is not less than 2 ~ 3 mg/ℓ. If the alkalinity is insufficient, the pH in the nitrification tank decreases from the effect of the generated nitric acid. In the biological denitrification process, 3.57 mg/ℓ of alkalinity is produced through the stage in which the organic nitrogen is decomposed to ammonia. In the nitrification reaction, 7.14 mg/ℓ of alkalinity is consumed for 1 mg/ℓ NH<sub>4</sub>-N. In addition, 3.57 mg/ℓ of alkalinity is produced from 1 mg/ℓ NO<sub>3</sub>-N in the denitrification reaction. If wastewater contains enough alkalinity, the pH in the nitrification tank does not decline. If the alkalinity is insufficient, the pH goes down, but the nitrification rate does not decrease noticeably until the pH reaches around pH 6. When the pH declines further, it shall be adjusted by neutralization using an alkaline like NaOH. Nitrification bacteria, compared with microorganisms in activated sludge, is more sensitive to temperature, and the nitrification seriously deteriorates below 10 °C. As a measure to prevent deterioration, increasing nitrification bacteria concentration is economical, but warming the nitrification tank becomes necessary if it is difficult.

## REFERENCES

- 1) Hasegawa, S. Diagnosis of Bulking and Practical Measure, *The Best Treatment of Food Processing Wastewater Handbook*, p 357 (Science Forum, 2002).
- 2) Eckkenfelder, W. et al. *Biological Waste Treatment* (translated by Iwai), p 68 (Korona, 1965).
- 3) Hashimoto, S. et al. *Advanced Activated Sludge Process*, p 71 (Sangyo Yosui Chosa Kai, 1986).
- 4) Takamura, Y. et al. Anaerobic Treatment Facility, *The Best Treatment of Food Processing Wastewater Handbook*, p 110 (Science Forum, 2002).
- 5) Hogetsu, A. Et al. Biomass Control in a Fixed Bed Anaerobic Reactor, *J. Fermentation and Bioengineering*, Vol. 67, No. 3, p 200 (1989).
- 6) Hogetsu, A. Et al. Effect of temperature in Anaerobic Digestion, *Environment Engineering*, Vol. 30, No. 1 (1989).
- 7) Hogetsu, A. Feature and Application of Anaerobic Digestion under Comparison with Aerobic Process, *Environment Engineering*, Vol. 19, No. 12 (1990).

**Part 3 Examples of Food Processing  
Wastewater Treatment**

## **Part 3 Examples of Food Processing Wastewater Treatment**

### **Chapter 1 Raw Food Material and Wastewater from Production Process**

#### **1.1. Products and Characteristics of Wastewater**

The characteristics and volume of wastewater discharged from food processing factories vary with the products and production procedures. In factories like accompanying dishes makers and beverage makers, due to changes of products and/or production the wastewater fluctuates in characteristics and volume. Starch making factories in Hokkaido and sake breweries produce for a specified period of the year and only generate wastewater then. Almost all the wastewater in food processing factories is treated using a biological treatment process. The wastewater qualities and treatment methods are summarized in Table 3-1-1. The characteristics of wastewater from food processing factories are characterized by high BOD, SS, and oil concentrations as well as emitting smells from acidification. When aerobic or anaerobic biological processes are applied to wastewater treatment in food processing factories, removing oils and solids prior to the biological process is important for preventing them from disturbing the treatment.

#### **1.2 Treatment Process Selection**

When construction of a wastewater treatment plant is planned in food processing factories as well as in other industries, the wastewater properties, site conditions of the wastewater treatment plant, and economical efficiency of the treatment shall be considered for selecting the treatment process. The basic flow in food processing factories is the regulation, aeration, and settling tanks. Although activated sludge and the lagoon were the most widely used processes before the beginning of the 1990s, new processes offering improved capability, lower cost performance, and better care for the environment have taken their places in recent years. A representative type is anaerobic treatment, which has enabled economically stable treatment, owing to the development of technology for drastically upgrading the anaerobic microorganism holding density. As the result, direct discharge of effluent from the process to the sewer has been permitted where sewerage systems are available. As wastewater from food processing factories contains a high portion of organic matter, a hybrid system combining anaerobic and aerobic processes with anaerobic pre-treatment can contribute to substantial

Table 3-1-1 Typical industrial wastewater characteristics and treatment methods

Industries	Wastewater	Major pollutants									Typical treatment methods
		pH	BOD	COD	SS	Oil	N	P	Color	Others	
Food	Brewery		○	○	○						AS, AD
	Beverage		○	○	○						AS, AD
	Vegetable oil		○	○	○	⊙					OS, AS, AD,
	Milk/daily product		○	○	○						AS
	Starch		○	○	○	⊙					AS
	Daily dishes		○	○	○						AS
	Confectionary		○	○	○						AS
Petroleum refinery	Refinery			○		⊙				smell	OS, AS, AD,
Chemistry	Petrochemistry	○	○	○							N, FL, AS, AD
	Chemical fertilizer	○	○	○	○		⊙	⊙			N, AS, DN, PR
	Polymer chemistry	○	○	○							N, AS, AD
	Organic chemistry	○	○	○		○					N, FL, AS, AD
	Oil/fat			○	○	○					OS, FL, AS
	Pharmaceuticals		○	○	○						AS
Steel	Blast furnace			○	○						CS, FI
	Steel, hot mill			○	○	○					OS, FI, CS, FI
	Col mill	○				○					N, FI
	Cokes		○	○		○	⊙		○	phenols	N, OS, AS, FI
Paper/pulp	SKP		○	○	○				○	smell	IC, AS
	KP	○		○	○				○	smell	CS, FL, BL
	SCP, CGP		○	○	○				○	smell	CS, FL, AS, IC
	Washing/screening				○						FL, AS
Dyeing	Desizing		⊙	○	○						CS, FL, AS
	Scouring			○							CS, FL, CH
	Bleaching			○							CS, FL, CH
	Dyeing			○					○		N, CS, FL, O3
Machinery	Semiconductor	○	○	○						fluoride	N, AS, CS, FI, MF, O3
	Automobile					○					FL, FI, MF
	Plating	○								cyanide	N, FL, CS, CH, O3
Fiber	Wool		○	○	○						CS, AD, IC
	Synthetic fiber	○	○	○							N, CS, FL, AS

Remarks: (1) treatment methods, N: neutralization, FI: Filtration, OS: oil separation, CS: coagulation-settling

FL: dissolved air floatation, AS: aerobic biological treatment,

AD: anaerobic biological treatment, MF: membrane separation,

CH: chemical treatment, O3: ozonation, chlorination, IC: incineration

DM: denitrification, PR: phosphorous removal, BL: black liquor recovery

(2) specifically heavily polluted items are marked by ⊙

(3) in case of advanced treatment, filtration, activated carbon absorber and membrane separation are provided in addition to above unit operations

energy savings by producing methane gas. One defect in the activated sludge process is sludge bulking. New technologies, however, such as the floating media biofilm activated sludge process and the activated sludge process equipped with UF membrane instead of the settling tank, have been developed to prevent bulking problems. The effluent standards have lately become more stringent, and the nitrogen removal requirement is being specially strengthened. Denitrification processes have been dramatically improved by developing the technology of the single-phase sludge circulating denitrification process and equipment like floating medias holding high-density anaerobic microorganisms. Advanced treatment including coagulation-sedimentation, high-rate sand filtration, and dissolved air floatation is used for removing BOD, COD, and SS. For removing color, coagulation-sedimentation, ozonation or



## Chapter 2 Beverages

### 2.1 Wastewater Volume and Qualities

As the raw water qualities used in beverage factories significantly affect the products, better quality water than tap water is used as the raw material, after being treated by chemical dosing coagulation, sand filtration, activated carbon filtration, degasification, and other processes. As shown in Figure 3-2-1, carbon dioxide gas, sweeteners like sugar or syrup and flavors are dissolved into the water. Much of the wastewater comes from washing and rinsing cans, bottles, cleaning equipment, containers, floor, etc. Although wastewater volume varies with the products and factories, water 10 times the product ingredients is generally needed and has to be treated. As a standard<sup>1)</sup>, the wastewater volume is about 50 m<sup>3</sup> for producing 1,000 standard containers. Carbonated drink ingredients are shown in Table 3-2-1<sup>2)</sup>. Wastewater qualities are shown in Table 3-2-2<sup>2)</sup>. As the table clearly shows, wastewater is alkaline because alkaline detergents are used in washing. Since BOD and SS concentration are high, direct discharge into public waters without treatment causes environmental pollution.

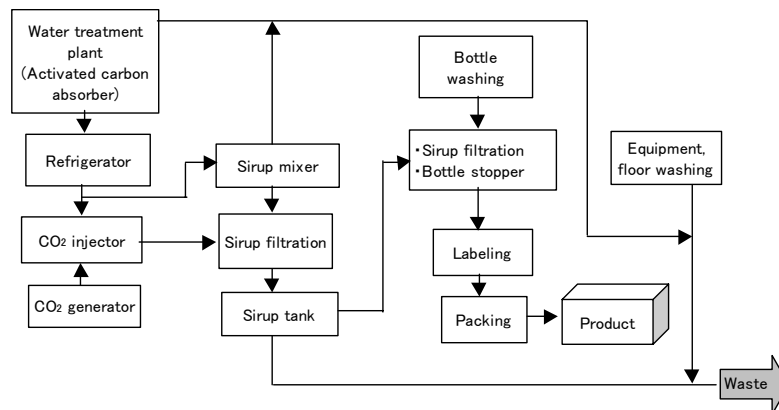

Figure 3-2-1 Carbonated beverage manufacturing process and wastewater

Table 3-2-1 Properties of carbonated drink

Carbonated drink	BOD (mg/l)	Total solids (mg/l)	Total acidity (mg/l)	pH
Coke	67,400	114,900	1,526	2.4
Pepsi Cola	79,500	122,000	1,466	2.5
Canada Dry	64,500	101,300	3,150	2.4

Table 3-2-2 Wastewater properties in carbonated drink factories

Factories	pH	Total alkalinity (mg/l)	BOD (mg/l)	SS (mg/l)
A	10. 6~11. 4	390	380	170
B	10. 0~11. 2	250	660	160
C	10. 4~11. 2	220	250	340
Average		290	430	220

## 2.2 Example of Actual Treatment<sup>3)</sup>

### 1. Design Condition

Main product	Coke
Containers	Glass bottles, plastic bottles, cans
Wastewater volume	4,000 m <sup>3</sup> /d, hourly peak flow 300 m <sup>3</sup> /h
Wastewater qualities	BOD 400 mg/ℓ (daily average)
	pH 5.8~11.0
	SS 50~70 mg/ℓ
Effluent qualities	BOD 30 mg/ℓ (daily average)
	pH 7.0~8.0
	SS 20~30 mg/ℓ

### 2. Process

As this factory was located in an area where the effluent standards were lenient and sufficiently wide space was available for wastewater treatment plant, the lagoon process was adopted due to the ease of operation and limited sludge generation. Figure 3-2-2 shows the wastewater treatment scheme. After large floating solids are removed in the grid-oil separator tank, the raw water flows into the lagoon, where it is oxidized and decomposed by the activated sludge therein. As the lagoon is 20,000 m<sup>3</sup> in total capacity and uses 5 days detention time, the BOD-MLSS load is 1/5~1/10 of the conventional activated sludge process. The endogenous respiration is accelerated and limited excess sludge is generated. The lagoon is divided into four parts, and the aerator in each part is intermittently operated for supplying oxygen and agitating the water. The last part of the lagoon plays a dual role, the final upgrading of the quality by aeration and removing the sludge by settling. Aeration is given for 4~7 hours a day and the supernatant, relieved of sludge, is discharged from a gate taking 12 hours during the aeration halt, while part of the finally settled sludge is returned by pumping to the first part of lagoon. As the wastewater tends to be short of nitrogen and phosphorous, nutrients for activated sludge, urea, and phosphate ammonium are dosed as supplements.



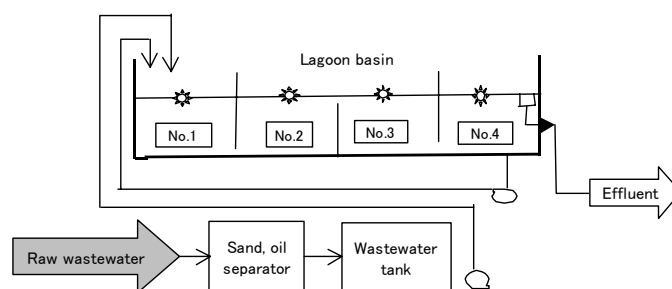

Figure 3-2-2 Schematic flow of Carbonated beverage manufacturing wastewater treatment

### 3. Performance Results

Although this wastewater treatment facility is located in Sapporo where the outdoor temperature goes down to nearly  $-15^{\circ}\text{C}$  in winter, the water in the lagoon is kept at  $8^{\circ}\text{C}$  due to the high raw water temperature. Good treatment is achieved throughout the year. Typical raw wastewater quality is shown in Table 3-2-3. The average, maximum, and minimum effluent qualities of the year are shown in Table 3-2-4. No sludge has been drained since 1974 when the operation started.

Table 3-2-3 Raw wastewater properties (monthly average)

Line	pH	COD ( $\text{mg}/\rho$ )	BOD ( $\text{mg}/\rho$ )	SS ( $\text{mg}/\rho$ )
1,2	10.1	320	162	3.8
3,4	10	175	151	16.6

Table 3-2-4 Treated water quality in carbonated drink wastewater treatment

Items	Temp. $^{\circ}\text{C}$	Water temp. $^{\circ}\text{C}$	pH	COD ( $\text{mg}/\rho$ )	BOD ( $\text{mg}/\rho$ )	DO ( $\text{mg}/\rho$ )	SS ( $\text{mg}/\rho$ )	Trans- parent	Coli form (No./ $1\text{m}\rho$ )
Yearly average	10.7	16.7	7.3	9	2.6	4.5	4.3	40	105
Maximum	33	25.4	7.6	11.3	5.4	9.2	11.3	50	279
Minimum	-15	8.5	7.1	7.8	1.6	1.7	2.4	20	2

### 2.3 Considerations in Operation and Maintenance

Though the lagoon process is operated easily, sludge bulking tends to occur. It is important to maintain a well-balanced ratio of BOD, N, and P control the bulking. As the process is operated under low BOD-MLSS load conditions, the nitrogen in raw wastewater is oxidized into nitrate and then reduced to nitrogen gas under anoxic condition in the final part of the lagoon. Micro fine nitrogen bubbles adhering to sludge particles cause poor settling and carry-over of the sludge. This sometimes results in effluent quality deterioration and performance degradation due to MLSS reduction.

## REFERENCES

1. Ide, T. *Industrial Wastewater and Treatments*, p 423 (Gihodo, 1978).
2. Sotoike, R. *Water and Wastewater Handbook*, p 781 (Maruzen, 1992).
3. Aihara, R. Current Situation of Wastewater Treatment in Beverage Factories, *The Best Treatment of Food Processing Wastewater Handbook*, p 278 (Science Forum, 2002).

## Chapter 3 Breweries

### 3.1 Beer

#### 3.1.1 Wastewater Volume and Qualities

In the beer brewing process, malts, rice, and cornstarch are fed as supplemental raw materials into the breeding tank and saccharized. The malt liquid, then dosed with hops, is filtered. The filtrate, after heat-processed in a boiling caldron, cooling down to 7~10 °C, and being dosed with yeast, is fermented for 7~10 days before becoming the final product. The quality and volume of wastewater vary with the brewing process and if there is a malt producing process because some beer breweries now use dried malt mass-produced at malt-producing factories elsewhere. Figure 3-3-1 shows all the production lines and wastewater discharge points. A large volume of wastewater containing high BOD and SS is discharged from the stage of screw-press-dewatering filtered residues after the breeding tank, and the dewatered residue is fed to livestock because of high nutrient contents. Wastewater with high BOD and SS comes out of the hop separation tank too. After fermentation in the main fermentation tank, yeast is separated, washed, and reused. Part of it is also reused for food, medicine, and other uses. These processes, consuming water for washing and rinsing, are a main source of wastewater. Beer is aged in the after-fermentation tank washed after periodical draining of settled yeast, discharging wastewater. In the final filtration process residual yeast, insoluble proteins, tannins, and other items are removed from the brewed beer. Diatomite used in the process is washed out into the washing water of filter equipment, separated at the inlet of the wastewater treatment plant, and disposed of as solid waste. Heat sterilization is not applied for draft beer production. Therefore, a large quantity of wastewater is generated from washing filter equipment, as it is very important for microbial control of the product. The last production stage is bottling. The recovered bottles and casks are washed with alkaline and acid detergents, and residual beer and labels come out into the wastewater. The standard wastewater volume is generally about 10~20 times the beer produced<sup>1)</sup>.

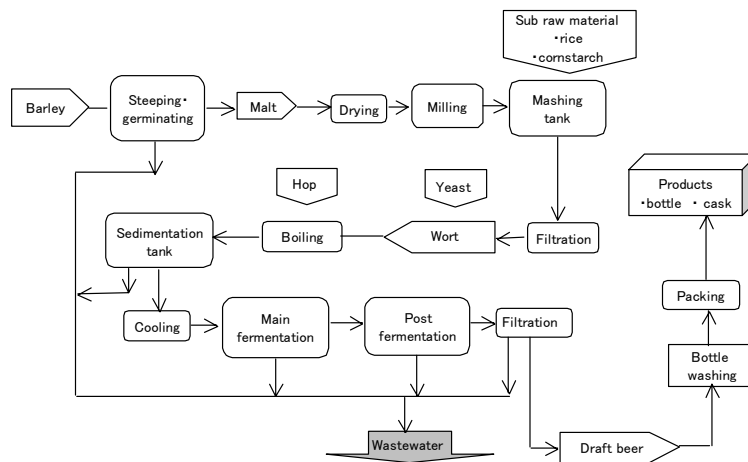

Figure 3-3-1 Beer brewery and wastewater discharges

### 3.1.2 Example of Actual Treatment

#### 1. Design Condition

Wastewater volume		7,000 m <sup>3</sup> /d (brewing=5,400 m <sup>3</sup> /d, bottling=1,600 m <sup>3</sup> /d)
Wastewater qualities	BOD	1,500 mg/l (brewing=1700 mg/l, bottling=300 mg/l)
	SS	65 mg/l (brewing=800 mg/l, bottling=150~300 mg/l)
Effluent qualities	BOD	< 20 mg/l (anaerobic effluent <200 mg/l, activated sludge effluent < 20 mg/l)
	SS	< 20 mg/l (anaerobic effluent <200 mg/l, activated sludge effluent < 20 mg/l)

#### 2. Process

This factory had treated previously wastewater with the activated sludge process and, when expanding production and after reviewing the performance, added an anaerobic treatment process in order to cope with the increased production and reduce the wastewater treatment cost. Figure 3-3-2 shows the schematic flow diagram. In the screening chamber, floating solids are removed from the 7,000 m<sup>3</sup>/d wastewater; mixture of wastewater from the brewing, bottling, and canning processes, and the wastewater flows into the equalization tank. There it is divided into two parts, a part of 6,400 m<sup>3</sup>/d for the newly built anaerobic treatment plant and another part of 600 m<sup>3</sup>/d for the old activated sludge plant. Wastewater for the anaerobic treatment is removed of SS with the dissolved air floatation unit (DAF), neutralized by sodium hydroxide or hydrochloric acid, and then fed into an anaerobic treatment reactor

where the inner temperature is kept at 36°C by steam heating. Methane gas generated in the anaerobic treatment reactor is desulfurized, stored in a gas holder, and used for fueling the boiler. Scum separated by DFA is returned to the aeration tank to reduce the volume. While 600 m<sup>3</sup>/d wastewater for aerobic treatment flows into the aeration tank, the sludge is removed from the settling tank, mixed with the effluent from the anaerobic process, and then discharged into the sewer. Excess sludge (granule sludge) generated in the anaerobic treatment reactor is stored for making up the loss due to granule runoff. Excess sludge from the activated sludge process is thickened in the thickener, dehydrated, and then hauled out as industrial waste.

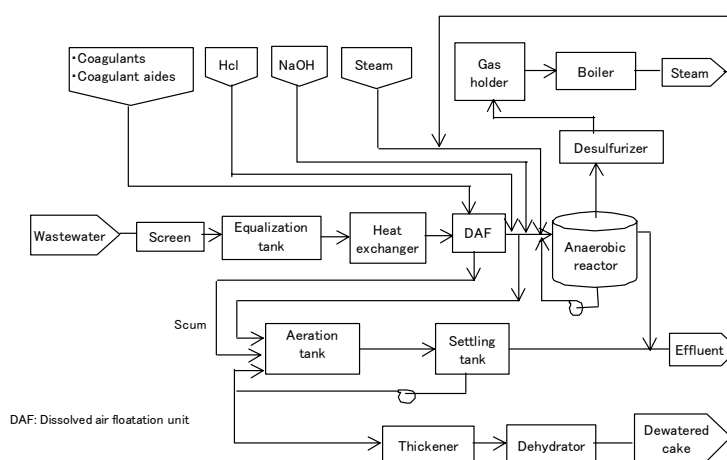

Figure 3-3-2 Schematic flow of beer brewery wastewater treatment

### 3. Performance Result<sup>1)</sup>

As the anaerobic process plays the main part of the wastewater treatment here, explanation of the aerobic process is omitted. Specifications of the anaerobic treatment facility are described in Table 3-3-1. The sludge load in the table means the BOD load of the sludge (granules) in the anaerobic treatment reactor, which is an important indicator for operation performance. Figure 3-3-3 shows the relations between the BOD-sludge load, temperature, and BOD removal rate. It is seen that if the temperature in the reactor drops, then the BOD removal rate falls down by about 5%. The figure also shows that if the temperature in the reactor is kept at 28°C or above, stable performance will be secured up to 0.6 BOD · sludge load (kg BOD/kg VSS · d). The BOD-sludge load in this plant is usually around 0.3 (kg BOD/kg VSS · d) and more than 90% of BOD removal is stably achieved at all times. Figure 3-3-4 shows the effluent quality under the influent's fluctuating load for 3 months, and it clearly indicates the stability of performance in spite of the fluctuations.

Table 3-3-1 Performance of anaerobic treatment in beer brewery wastewater

Items	Specifications
Temperature in reactor	35. 5°C
pH in reactor	7.2
Sludge load	0. 31kg BOD/kg VSS/d
Influent BOD	1, 420mg/ℓ
Effluent BOD	104mg/ℓ
Influent SS	117mg/ℓ
Effluent SS	135mg/ℓ
BOD removal rate	93%

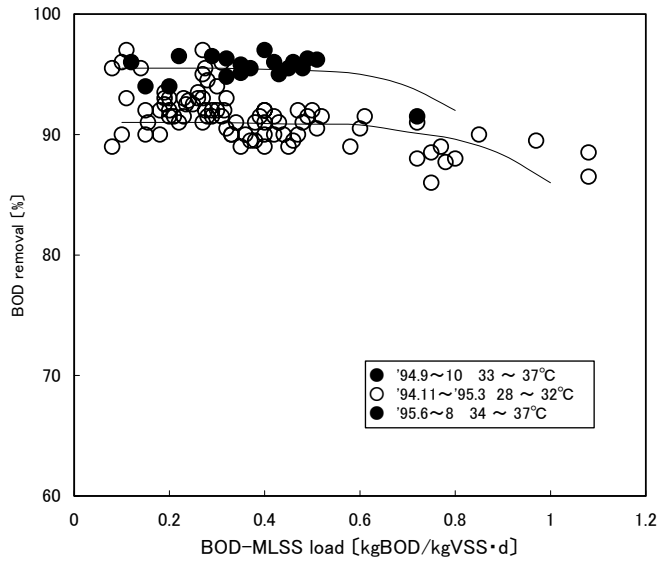

Figure 3-3-3 BOD-MLSS versus over BOD removal rate

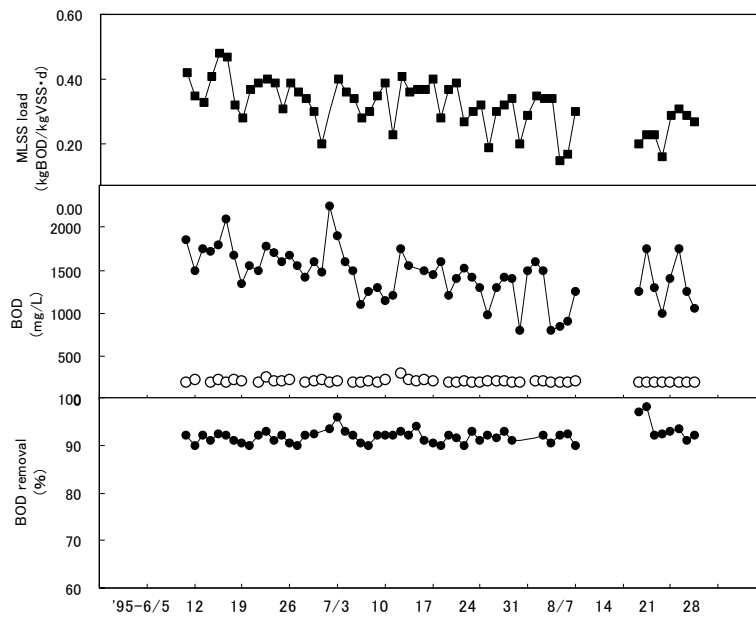

Figure 3-3-4 BOD-MLSS load and BOD removal rate in beer brewery wastewater treatment

### 3.1.3 Considerations in Operation and Maintenance

Two anaerobic methods are used in treating industrial wastewater. They are the UASB (Up-flow Anaerobic Sludge Blanket) process using microbial granulation and the fixed bed process using microbial biofilm on the surface of media. Though the UASB process can hold more anaerobic microorganisms per volume than the fixed bed process and makes a higher loading rate operation possible, it contains the risk of granule runoff. The major cause of granule runoff is that adherence of SS in raw wastewater to the granules makes it difficult to separate the gas bubbles from the granules. The relation between SS in influent raw wastewater and granule runoff from the reactor is shown in Figure 3-3-5. The allowable SS weight in influent raw wastewater shall be less than the weight of the multiplying granules in the reactor, which is 400 mg/ℓ in this case.

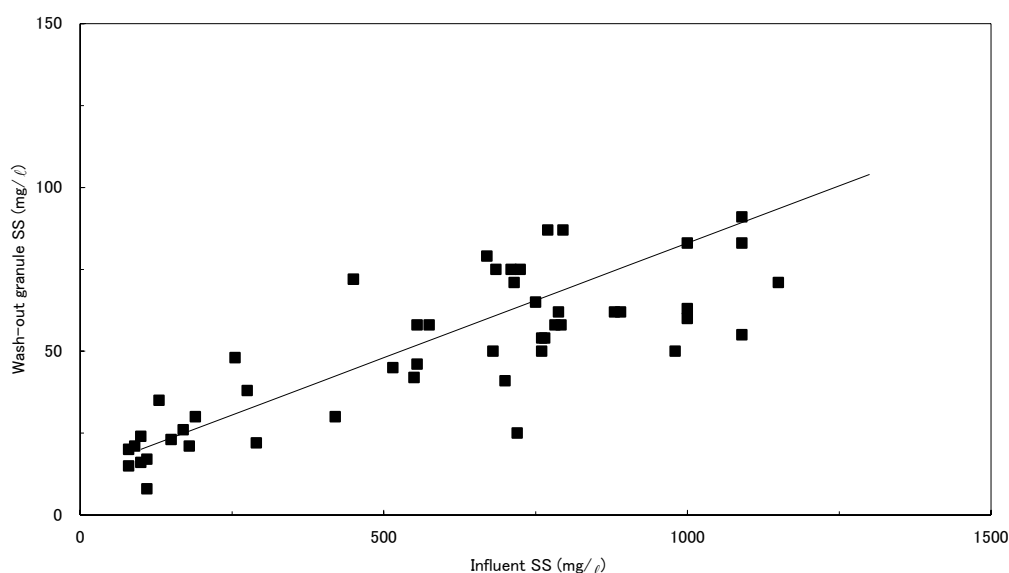

Figure 3-3-5 Relations between influent SS and wash-out granule SS

## 3.2 Sake

### 3.2.1 Wastewater Volume and Qualities

The relation between the process of brewing sake and generating wastewater is shown in Figure 3-3-6. Rice polisher washes rice bran off from polished rice, and starch flows out from the operation. As the major pollutant portions in sake breweries are discharged here, the pollutants for the wastewater treatment depend significantly on the volume of water used in the washing operation. Efforts to remove rice bran from polished rice by rotary shifters or dry rice polishers prior to washing have been made lately in order to reducing the wastewater



wastewater, to the aeration tank. The effluent from the activated sludge process, after separating SS in the coagulation-sedimentation and sand filtration tanks, is processed through activated carbon and chlorinated before it is discharged into the river. As the sake brewing wastewater tends to be short of nitrogen and phosphorous, urea and phosphate ammonium are dosed as supplement nutrients. Sediment materials from rice-wash-wastewater are used for livestock feed after being coagulated, thickened, and dehydrated by dosages of harmless coagulants.

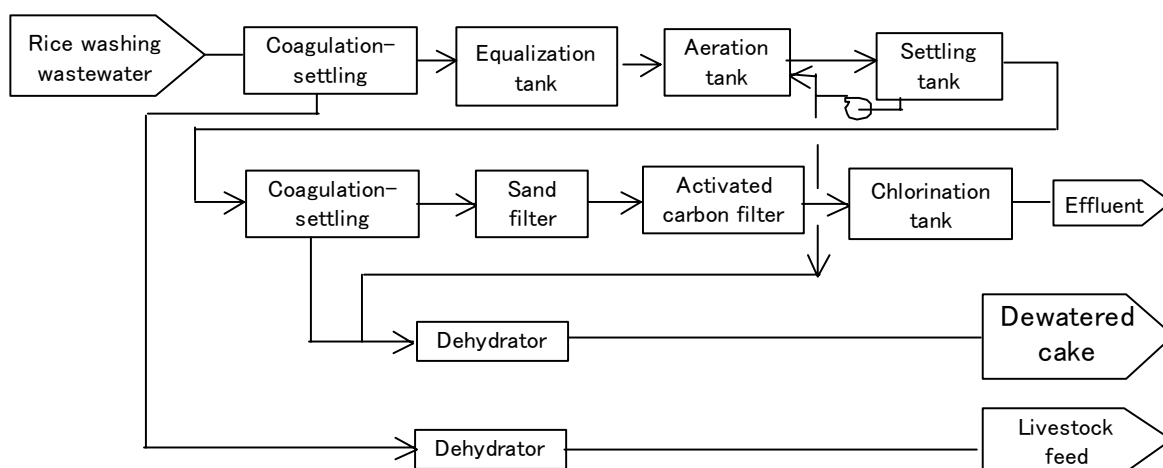

Figure 3-3-7 Schematic flow of rice washing wastewater

### 3. Performance Results

BOD and COD in the wastewater from washing rice can be substantially removed by coagulation-sedimentation. The test results of the properties of sampled wastewater and settlability are respectively shown in Table 3-3-2 and Table 3-3-3. The wastewater was sampled just after washing the rice and the removal rates of BOD and COD by coagulation-sedimentation were about 85% and 80%. The rates are lowered as time elapses, due to fast putrefaction of the wastewater. When the same testing was made for samples collected 48 hours after washing the rice, the removal rates of BOD and COD were down to 35% and 56%. These changes were caused by the solid contents in the wastewater being solubilized, and changing to soluble BOD and COD, and they made coagulation difficult. A test result of coagulating the wastewater is shown in Figure 3-3-8<sup>3)</sup>. The results show that SS coagulated with PAC 250 as a coagulant, and nonionic polyelectrolyte as a coagulant aid settles it very speedily. In this factory, the effluent BOD of activated sludge process is around 10 mg/l, and then it is lowered down to a few mg/l through the advanced treatment system.



Table 3-3-2 Rice-wash-wastewater properties for experiment

Appearance	pH	SS (mg/l)	COD (mg/l)	BOD (mg/l)
Cloudy	6.6	717	990	1,250

Table 3-3-3 Coagulation-settling test result for rice-wash-wastewater

Run	Chemical dosage volume (mg/l)				Coagulation states			Effluent qualities			
	Alum	PAC 250A	Noah	Konan-Floc	Floc stability	Settle-ability	Floc volume	pH	SS (mg/l)	COD (mg/l)	BOD (mg/l)
1	200	—	58	10	C	C	10	6.8	<50	230	215
2	300	—	105	10	C	C	12	6.7	<50	209	216
3	400	—	150	10	B2	B2	15	6.8	<30	196	215
4	500	—	200	10	B1	B1	16	6.8	<30	191	208
5	1,000	—	365	10	B3	B3	26	6.8	<30	179	185
6	—	200	15	10	C	C	10	7	<50	213	232
7	—	300	25	10	C	C	12	6.8	<30	219	232
8	—	400	42	10	B	B	15	6.9	<30	213	232
9	—	500	58	10	B	B	16	7	<30	213	221
10	—	1,000	94	10	C	C	23	6.8	<30	196	212

Remarks: coagulation states, settleability: B: good, B1: better than B, B3 best, C: normal

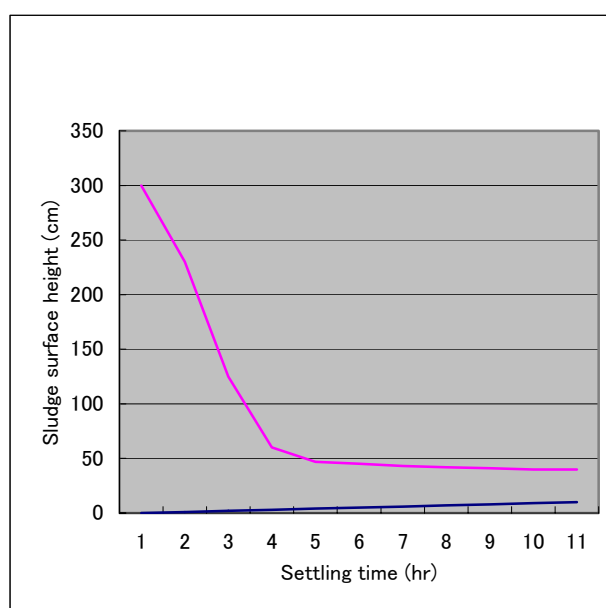

Condition: pH 7.0, PAC250A 390mg/l, Konan Floc 3000S 10mg/l

Figure 3-3-8 Settling test result of coagulated rice-washing-wastewater

### 3.2.3 Considerations in Operation and Maintenance

The important factor for securing continuous and stable performance in wastewater treatment is pre-treatment by coagulation-sedimentation. As described above, SS shall be coagulated, settled, thickened, and taken out of the treatment system before the wastewater

starts putrefying. Moreover, the settlability of activated sludge in sake brewing factories is inherently poor. This is due to the dispersion, poor settlability, and poor compaction of sludge caused by the viscosity from delayed polysaccharide decomposition, which originates from the nitrogen shortage in the wastewater. This phenomenon is called sludge bulking. Sludge bulking in sake brewing wastewater treatment is different from other bulking as the number of filamentous bacteria is few and viscous froth forms in the aeration tank. Adding nitrogen and bulking inhibitor effectively solves the problem. As most sake production is limited seasonally, wastewater is not generated for many months. For ready re-starting of wastewater treatment, molasses and rice bran are fed as nutrients during the off seasons to maintain the sludge activity. If a sewage treatment plant or wastewater treatment plant using activated sludge is located nearby, another method is importing live sludge a few days before start up, putting it in the emptied aeration tank, and acclimatizing it by feeding nutrients like rice bran to prepare it for receiving wastewater.

## REFERENCES

1. Ikemoto, H. Panbic-G Application to Beer Brewing Wastewater, *Shinko Pantec Technical Rep.* Vol. 39, No. 2 (1996).
2. Sotoike, R. *Water and Wastewater Handbook*, p 774 (Maruzen, 1992).
3. Sono, K. Rice-Washed-Wastewater Treatment, *Japan Brewing Association Journal*, 67, 376 (1972).

## Chapter 4 Oils and Fats

### 4.1 Wastewater Volume and Qualities<sup>1)</sup>

Vegetable oils are produced from rapeseed, corn, and soybean by the processes shown in Figure 3-4-1. The production line consists of two processes, extracting oils from raw materials and refining the extracted oils. The vegetable oil expression methods of industrial scale are classified into the expression, extraction, and expression-extraction methods. The expression method squeezes oils out of dried and heat-treated raw materials, leaving 4~7% oil content. The extraction method extracts oils from heat-treated raw materials using normal hexane as solvent. The expression-extraction method is a series of the expression and extraction methods. In the refining process, dust, saccharides, proteins, gummy substances, fatty acids, pigments, smelling substances, and other such items are removed. Phosphoric acid, sodium hydroxide,

and water are used in the process. Filtration aid is also dosed to improve filtration and refining. Water consumption volume per unit of raw material varies with the production capacity level of the vegetable oil manufacturing factory. Table 3-4-1 shows the annual production capacity level, percentage of consumption classified by different water sources (drinking, industrial, recirculated, sea, etc.), and the consumption volume per unit of raw material. The consumption volume per raw material unit varies from 30~80 m<sup>3</sup>/ton. Table 3-4-2 shows the annual production capacity level as well as the percentage of consumption classified by different processes and usages (cooling, production process, bottle washing, boiler, sanitary, etc.). Consumption in the production processes is relatively low percentage-wise except for cooling, and most of the wastewater comes from deacidifying and deodorizing operations in the refining process. Wastewater qualities generated by deacidifying and deodorizing operations are shown in Tables 3-4-3 and 3-4-4.

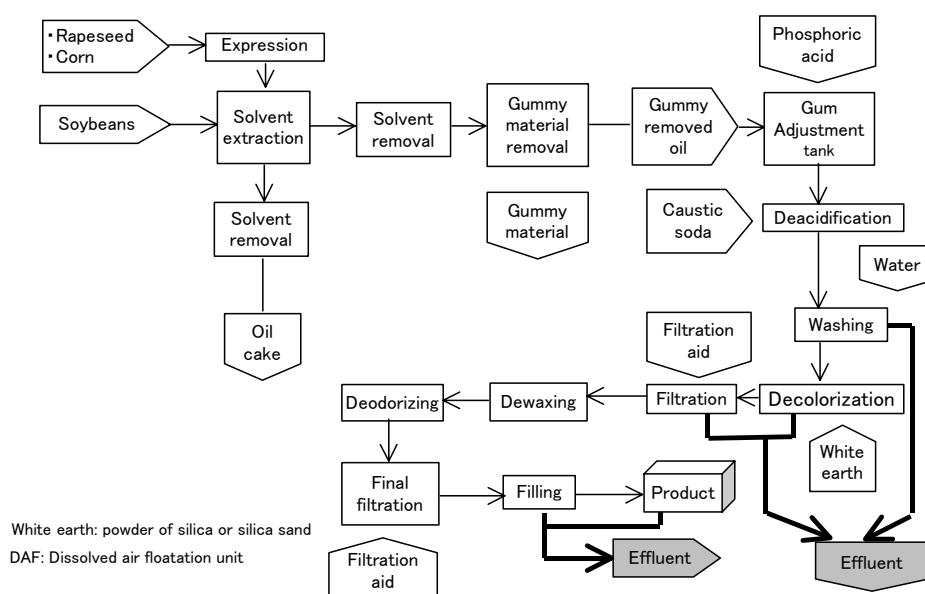

Figure 3-4-1 Schematic flow of vegetable oil processing and wastewater

Table 3-4-1 Plant scales and water consumption in vegetable oil manufacturing

Raw materials consumption (1,000 ton/year)	Service water usage ratio (%)					Water (m <sup>3</sup> ) per raw material (ton)
	Tap water	Industrial water	Recycle water	Sea water	Others	
<10	5	18.5	12.1	0	64.4	35.9
10~50	2.1	8.7	45.3	25.1	18.8	36.7
50~100	1	8.5	11	73.4	6.1	83.1
100~300	0.8	2.5	70.6	26	0.1	62.2
≥300	0.5	7.3	56	36.2	0	31
Average	0.8	6.1	53.9	36.2	3	41.9

Table 3-4-2 Water consumption rate at each process in vegetable oil manufacturing (%)

Raw materials consumption (1,000 ton/year)	Expression, extraction process		Refining process		Bottle washing	Boiler feed	Sanitary, others
	Cooling	Process	Cooling	Process			
<10	25.9	0	54.1	7.2	1.6	4.6	6.6
10~50	29.4	0.7	51	5.8	0.6	3.5	9
50~100	31.5	0.2	42.5	1.3	0.1	2.8	21.7
100~300	41.5	0.1	56.4	0.3	0.1	1.1	0.5
≥300	51.1	0	41.2	3.4	0.1	2.8	1.4

Table 3-4-3 Wastewater qualities of deacidification process

pH	6~7
COD	400~7, 400 mg/ℓ
N-hexane extract	1, 000~10, 000 mg/ℓ

Table 3-4-4 Wastewater qualities of deodorizing process

pH	neutral
COD	50~100 mg/ℓ
N-hexane extract	50~100 mg/ℓ
SS	30~400 mg/ℓ

## 4.2 Example of Actual Treatment

### 4.2.1 Example of Dissolved Air Floating Unit<sup>1)</sup>

When wastewater discharged from vegetable oil manufacturing is mixed with sea water, coagulation takes place. In Japan, many factories are located in coastal areas because imported raw materials are transported in bulk by sea, and the location facilitates using sea water for wastewater treatment. Table 3-4-5 shows reducing COD in soybeans oil wastewater by dosage with salt. When 30 g of salt is dosed for one liter of wastewater and agitated, floc is formed by coagulation and settles. This removes 90% of COD in the supernatant.

Table 3-4-5 Salting-out test result for vegetable oil manufacturing wastewater by dosing synthetic sea water

Run	Wastewater(mℓ)	synthetic sea water (mℓ)	COD in treated water (mg/ℓ)
1	100	200	574
2	100	300	193
3	100	400	133
4	100	100	447
5	100	100	275
6	100	200	247

COD in raw wastewater is 7,400 mg/ℓ

## 1. Process

The schematic flow of two-stage dissolved air flotation units (DFA) are shown in Figure 3-4-2. Almost the same amount of sea water as wastewater is added in the first stage DFA. The condensed scum is dewatered and carried out as industrial waste. The effluent from the first-stage DAF is adjusted for pH and dosed coagulant, and then treated in the second-stage DAF before being discharged. The second stage scum is dewatered similarly as the first stage scum. The volume is about 20% wastewater and contains 5% solids.

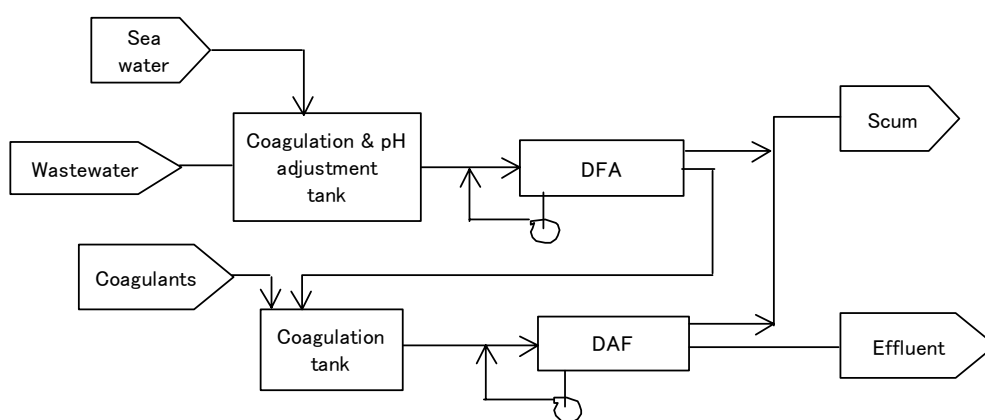

Figure 3-4-2 Dissolved air flotation (DFA) treatment of vegetable oil processing factory

## 2. Performance Results

More than 90% of COD is removed at the first stage DAF and 80~90% of remaining COD is further removed at the second stage DAF.

### 4.2.2. Example of Biological Treatment

#### 1. Design Condition

Wastewater volume		600 m <sup>3</sup> /d
Wastewater qualities	BOD	8,000 mg/ℓ
	TOD	14,000 mg/ℓ
	SS	1,700 mg/ℓ
	N	400 mg/ℓ
Effluent qualities	BOD	<280 mg/ℓ
	SS	<280 mg/ℓ

## 2. Process

This treatment plant can concurrently recover methane from organic materials in the wastewater, reduce the load on the activated sludge process, save energy consumption, and reduce excess sludge generation. The schematic flow of the treatment plant is shown in Figure 3-4-3. The raw wastewater is adjusted for the temperature by heat exchanger and fed to the anaerobic treatment reactor, where the temperature is kept at around 36°C, and the floating media are fully filled. Anaerobic microorganisms held on the surface of the media generate methane by decomposing organic materials. Then the effluent is fed to the upstream denitrification tank where nitric acid in the returned sludge water from the settling tank is reduced to generate nitrogen gas. After denitrification, organic materials in the effluent from the denitrification tank are oxidized and nitrified in the aeration tank. Then, the effluent is fed to the downstream denitrification tank where nitrogen is removed again by reducing the nitric acid. The effluent from the denitrification tank is separated from the sludge at the settling tank, and finally discharged. Settled sludge in the settling tank is returned to the upstream denitrification tank. Methane gas generated in the anaerobic treatment reactor has hydrogen sulfide removed by the desulfurizer and is used for the fueling boiler. Generated steam is used for heating the anaerobic treatment reactor.

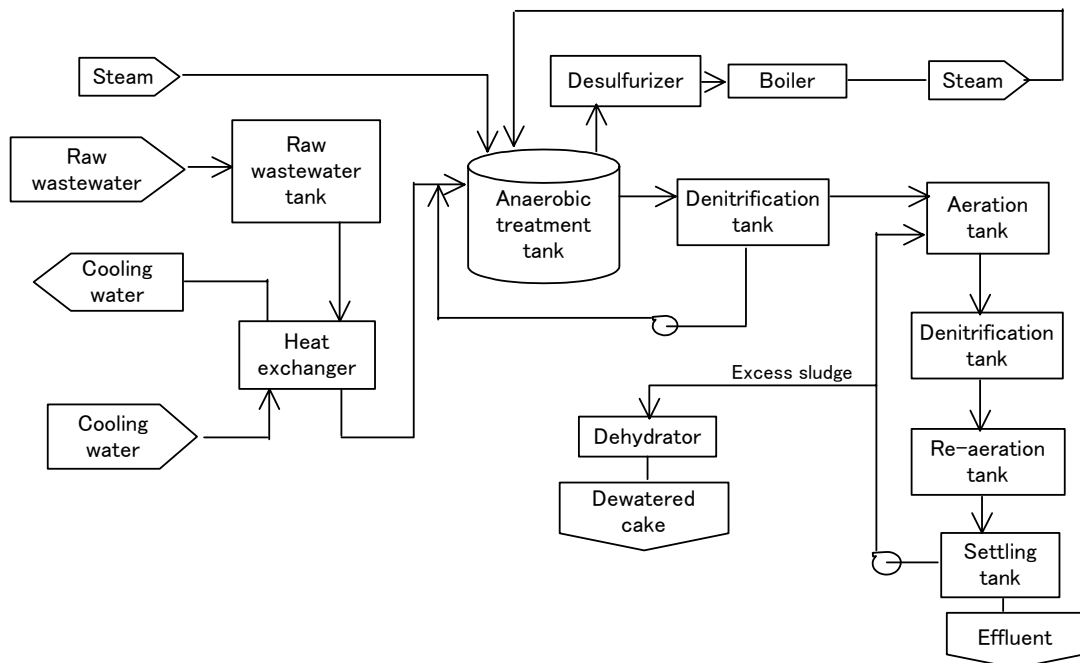

Figure 3-4-3 Schematic flow of vegetable oil processing wastewater treatment

### 3. Performance Results

It took some time before the anaerobic microorganisms adhered, grew, and held on to the media surface in this fixed bed type anaerobic treatment reactor. Since then, however, the reactor has maintained stable operation, maintaining over a 70% removal BOD rate, despite the unexpected and sudden substrate changes in the wastewater and load conditions. The activated sludge process downstream keeps the BOD reduction stable at more than 90%. The volume of generated gas varies affected by pH in the anaerobic treatment reactor. When the pH goes on the alkaline side, the volume decreases due to the higher solubility of the carbon dioxide, and when the pH inclines to the acid side, the volume increases. If pH is kept at 6~8, the methane gas content in the generated gas is almost equal to the theoretical value. The volume of generated excess sludge is 1/3~1/5 of the aerobic biological process. Energy savings and sludge volume reduction, goals of introducing the processes, have been attained in this plant.

#### 4.3 Considerations in Operation and Maintenance

Although the wastewater volume in vegetable oil factories is relatively small and fluctuates less, removing oil sufficiently in the oil separator for pre-treatment is important because of the high oil content. Especially in the case of anaerobic and activated sludge treatment, much attention is paid to the oil removal. In the case of two stage dissolved air floatation, the effects of coagulants in the second-stage coagulation are influenced by alkalinity and salt concentrations in the wastewater. Therefore, coagulating conditions shall be optimized by using jar testing. The coagulating conditions of wastewater differ for raw materials like rapeseeds and soybeans and understanding them is important for sludge management.

### REFERENCES

1. Hori H. Oils and Fats Product, *The Best Treatment of Food Processing Wastewater Handbook*, p 308 (Science Forum, 2002).

## Chapter 5 Milk and Dairy Products

### 5.1 Wastewater Volume and Qualities<sup>1)</sup>

The production lines of milk and dairy products are shown in Figure 3-5-1. In the milk and dairy product processing factories, water is used for washing, cooling, air conditioning, boilers, sanitation, etc. The wastewater originates from washing equipment, machines, floor,

etc.; accidental leakage of raw materials and products; and dumping off-spec products and contaminated raw materials and products. Figure 3-5-2 shows, in percentages, the water consumption by various processes. About 60% of wastewater comes from washing. After production works terminate, the equipment used is cleaned by chemicals and, before and after the cleaning, washed and rinsed with water. Thus, the wastewater is generated. Table 3-5-1 shows the properties of wastewater and the generated volume per unit of product, classified by the products. As production of milk and dairy products peaks in the summer, so does the wastewater volume. Depending on the degree of production activities, the volume and pollutant concentration of wastewater fluctuates within a 3 to 1 range by the hour and 2 to 1 by the day. The pollution load is especially high on the weekends.

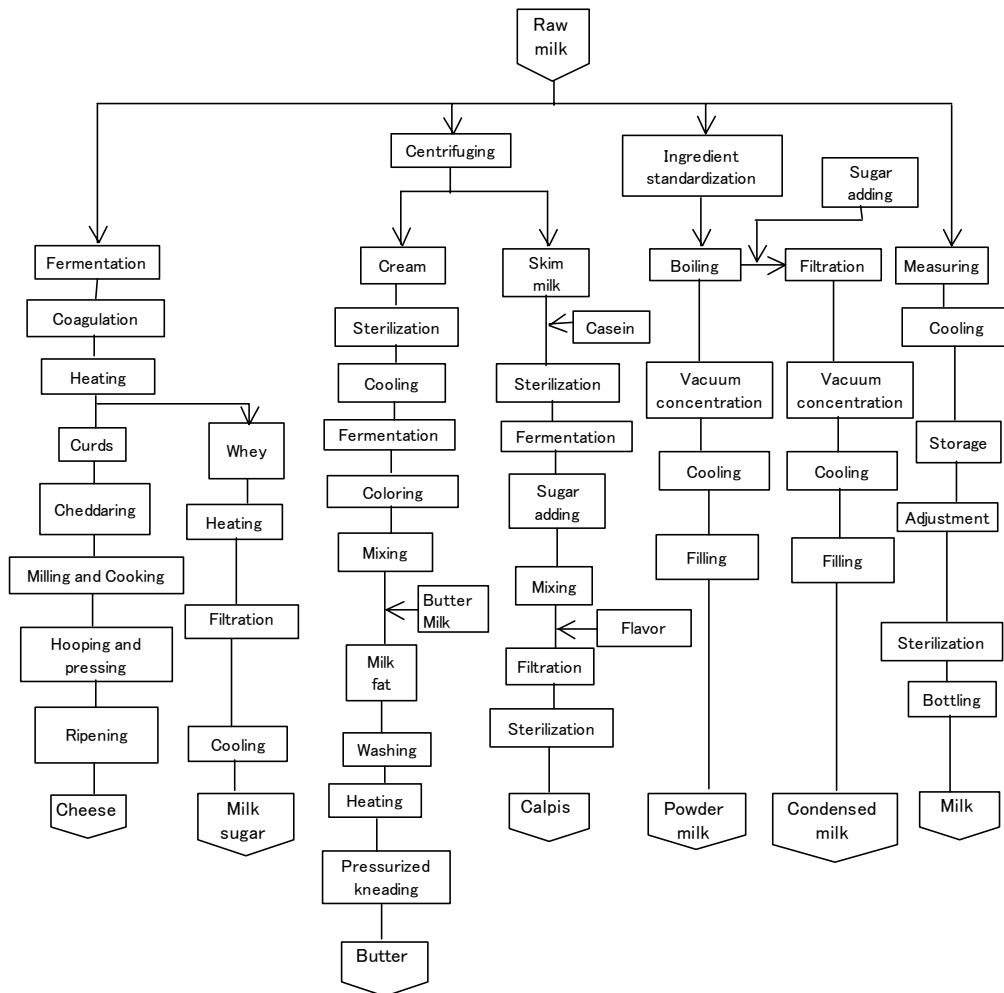

Figure 3-5-1 Schematic flow of milk and dairy products



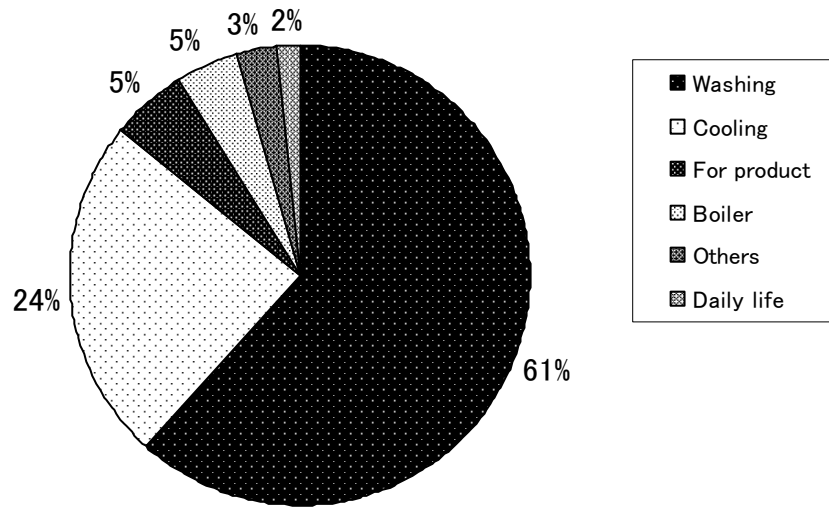

Figure 3-5-2 Water consumption rate by various processes

Table 3-5-1 Wastewater volume and qualities in milk and dairy product processing factory

Product	pH	BOD	COD	SS	Oil <sup>※</sup>	Water/product m <sup>3</sup> /ton
		mg/ℓ	mg/ℓ	mg/ℓ	mg/ℓ	
Milk, milk drink	11	750	400	150	90	10
Dairy products	10	600	300	100	60	3
Desserts	11	750	350	250	130	13
Cold cakes	11	800	400	200	200	20

※ N-hexane extract

## 5.2 Example of Actual Treatment

A conventional activated sludge process in milk and dairy product processing factories is applied to this factory<sup>2)</sup>.

### 1. Design Condition

Wastewater volume                    540 m<sup>3</sup>/12 hr./d (factory; 12 hours operation)

Wastewater qualities    pH            8.4  
                                   BOD       200 mg/ℓ

Effluent qualities        pH            6~8  
                                   BOD       20mg/ℓ  
                                   SS          20 mg/ℓ  
                                   COD       20 mg/ℓ  
                                   Coli No. < 330/mℓ

## 2. Process

As the hourly and daily fluctuations of volume and pollutant loads of wastewater are large, it is desirable for the conventional activated sludge process that the wastewater be sent to the aeration tank after equalization of the fluctuating quantity and quality in the equalization tank. Although an extended aeration process is sometimes adopted for stability against load fluctuations and easy operations, it needs more space than the activated sludge process. In this example, the activated sludge process was adopted. Nutrient supplements are not needed because the wastewater contains BOD, nitrogen, and phosphorous in a well-balanced ratio. Although excess sludge generation in the activated sludge process is generally higher than in the extended aeration process, the excess sludge in this plant was reduced to the same volume as in the extended aeration process by aerobic digestion of thickened sludge. The schematic flow of this plant is shown in Figure 3-5-3. The raw wastewater is screened for floating solids, equalized in the equalization tank, and fed to the aeration tank. After separating the sludge in the settling tank, it is sterilized by chlorine, and then discharged. Excess sludge is oxidized, and the volume is reduced in the aerobic digestion tank.

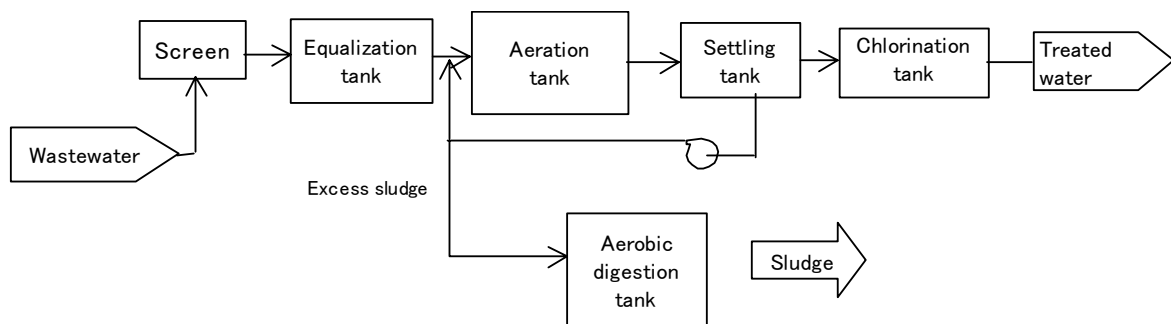

Figure 3-5-3 Schematic flow of wastewater treatment of milk and dairy product factory

## 3. Performance Results

The operation results in this plant are shown in Table 3-5-2. In spite of the pollutant concentrations in the raw wastewater being lower than the design figure, the BOD in the effluent sometimes exceeded 20 mg/l of the design figure during the period just after start-off when the MLSS concentration is low. BOD in the effluent, however, has decreased responding to the increase of MLSS. Excess sludge is aerated for 10~20 days in the aerobic digestion tank, oxidized, reduced in volume, and then returned to the aeration tank. By this operation, the processed excess sludge balances, in weight, the SS carried out into the effluent, and eliminates the need for sludge transportation to the outside.

Table 3-5-2 Milk and dairy wastewater treatment result by activated sludge process

Date	Raw wastewater				Aeration tank		Treated water			
	pH	BOD (mg/ℓ)	COD (mg/ℓ)	SS (mg/ℓ)	MLSS (mg/ℓ)	DO (mg/ℓ)	pH	BOD (mg/ℓ)	COD (mg/ℓ)	SS (mg/ℓ)
1-May	7.6	121	41	6	1,200	4.2	7.1	19	7	22
5-May	7.3	134	46	17	1,110	4.6	7.1	22	7.4	16
10-May	7.4	110	36	8	1,308	3.2	7.2	16	5.1	18
10-Jul	7.1	140	47	5	2,100	3.6	7	11	3.4	8
10-Sep	6.8	96	31	3	1,860	2.8	7	14	5.2	6
10-Oct	7.4	126	40	6	2,460	3.2	7.1	18	6.1	10
10-Nov	7.6	118	40	4	3,120	3.8	7.2	12	4.2	8
10-Dec	7.2	180	58	9	3,080	3.8	7	12	4.8	20

### 5.3 Considerations in Operation and Maintenance

In wastewater treatment of milk and dairy products, sludge settlability sometimes becomes poor and accordingly SS concentration in the effluent rises. It is caused by the over-aeration of activated sludge. Over-aerated sludge floc becomes less coagulable, disperses in water, and does not settle. Relations between the MLSS concentrations and SV<sub>30</sub>, an indicator of sludge settlability (height of the settled sludge blanket after 30 minutes settling, %) for both the activated sludge process and extended aeration process are shown in Figure 3-5-4<sup>1)</sup>. When the MLSS concentration rises, the DO concentration falls, and the treatment performance deteriorates. In this case, MLSS shall be lowered by extracting sludge to resume the DO level at 1~2 mg/ℓ.

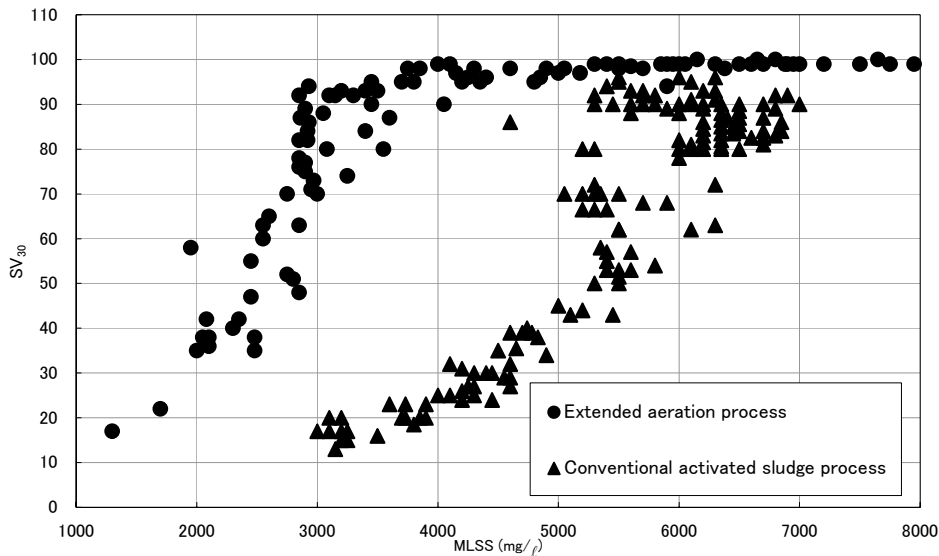

Figure 3-5-4 Relations between MLSS concentration and SV<sub>30</sub> in activated sludge process and extended aeration process

## REFERENCES

1. Yazaki, M. Milk and Dairy Products, *The Best Treatment of Food Processing Wastewater Handbook*, p 298 (Science Forum, 2002).
2. *Wastewater Treatment in Food Processing Factories*, Shinko Pfaudler Technical Report, Vo. 13, No. 4 (1970).

## Chapter 6 Agriculture Product Processing

### 6.1 Wastewater Volume and Qualities

The industries consuming a lot of water in agriculture product processing include producers of wheat starch, potato starch, sweet potato starch, and sugar. Potato starch processing factories are located in the main potato producing area in Hokkaido, while wheat starch processing factories and sugar factories are located where sufficient water and convenient sea transportation are available because they import their raw materials from overseas. The wastewater treatment processes are, therefore, characterized by these geographical locations. Water used in wheat starch processing is 7~15 times, by weight, of the raw wheat, and the water consumption varies depending on the production methods. Main pollutants in the wastewater are BOD and SS, and they become putrid easily. The wheat starch production process and the wastewater generation points are shown in Figure 3-6-1<sup>1)</sup>. The typical wastewater qualities of wheat starch processing are shown in Table 3-6-1. Water used in potato starch processing is 13~44 m<sup>3</sup> per ton of potatoes<sup>2)</sup>. The difference in water consumption per raw material unit (unit water consumption) depends on the starch recovery rate in the separation process, in which starch, milky liquid, and lees are separated from the smashed potatoes and some ingredients are refined and condensed. This separation process is the major source of wastewater. Potato starch processing factories are generally small scale and discharge a large volume of wastewater with high BOD and SS concentration. These factories are mostly operated in the seasons between the end of summer and early winter. The typical wastewater qualities of potato starch processing are shown in Table 3-6-2. The unit water consumption in sweet potato starch processing is about half of potato starch processing, but the amount of generated BOD is nearly equal. In Japan, sugar industries previously used sugarcane and beet as raw materials, but sugarcane has faded out, and they now focus production on refining imported crude sugar. Cane sugar production consumes 15~20 times the water per ton of raw material and discharges high concentrations of BOD and SS, while water consumption as well

as the concentration of BOD and SS are low when using imported crude sugar. In beet sugar processing, wastewater of 8~10 times the weight base of raw materials is discharged from the flume-process in which beets are transported and washed in the flowing water, occupying 50~60% of the total wastewater. Other major sources of wastewater are the lime-cake process for extracting sugar from the beets, the Steffen process for recovering sucrose from spent molasses, and the ion exchange process which has lately replaced the Steffen process. Although the wastewater volume ratio per unit of raw material varies in different factories, generally it is about 1.3 times for the lime-cake wastewater, 30~40% for the Steffen wastewater, and 25~30% for the ion exchanger wastewater <sup>3</sup>. Wastewater qualities in beet sugar processing are shown in Table 3-6-3.

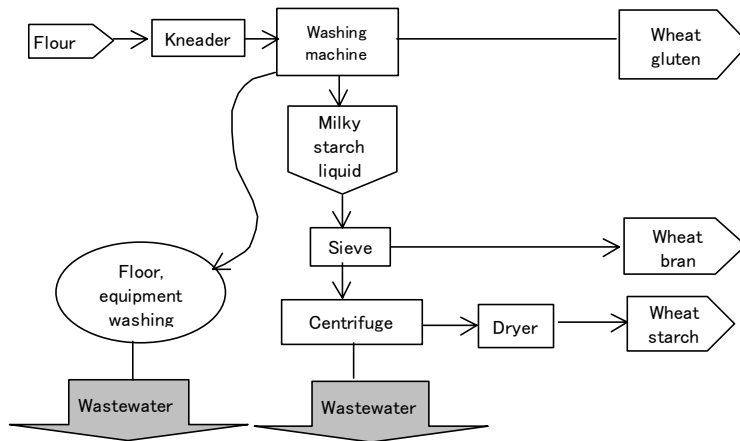

Figure 3-6-1 Schematic flow of wheat starch manufacturing process and wastewater

Table 3-6-1 Wastewater qualities of wheat starch processing

Items	Max.	Min.	Aver.
pH	4.4	5.4	-
TS (mg/ℓ)	12,800	16,400	14,600
DS (mg/ℓ)	10,140	12,000	11,100
SS (mg/ℓ)	2,600	4,400	3,500
COD <sub>cr</sub> (mg/ℓ)	-	20,600	18,750
BOD (mg/ℓ)	9,400	13,200	11,300
TOC (mg/ℓ)	4,600	5,800	5,200
T-N (mg/ℓ)	500	600	550
T-P (mg/ℓ)	170	190	180

Table 3-6-2 Wastewater volume and pollutants load of potato starch processing (per ton of raw materials)

Items	Flume-process wastewater	Separation-process		Total	
		Conventional	Concentration	Conventional	Concentration
Wastewater volume (m <sup>3</sup> )	4. 4~31	7~4	-	13~44	-
BOD (kg)	0. 1~2. 0	13~15	6. 2~16	14~56	17~40
SS (kg)	1. 3~57	10~44	0. 6~12	12~67	8~22

Table 3-6-3 Wastewater qualities of beat sugar processing

Items	Flume process	Lime -cake process	Steffen process
pH	6. 7~7. 4	-	12.5
BOD ( mg/?)	200~630	1,420	4,000
SS (mg/?)	700~3, 090	2,860	1,300
TDS (mg/?)	-	3,313	7,000

**6.2 Example of Actual Treatment (wheat starch)<sup>1), 4)</sup>**

A wastewater treatment plant in factories manufacturing wheat starch and wheat gluten from flour is described here. Being introduced for the pre-treatment of the existing activated sludge process, this plant has contributed to energy savings, reducing excess sludge generation, and stabilizing operation of the activated sludge treatment plant.

1. Design Condition

- Wastewater volume      maximum 550 m<sup>3</sup>/d, average 500 m<sup>3</sup>/d
- Wastewater qualities    CODcr    maximum 20,000 mg/l,    average 16,000 mg/l
- Effluent qualities        CODcr    removal rate: >80 %,    effluent of anaerobic treatment reactor

2. Process

The schematic flow diagram is shown in Figure 3-6-2. The raw wastewater flows from the equalization tank, through the heat exchanger, to the anaerobic treatment reactor. The anaerobic treatment reactor is filled inside by floating plastic media, and 7 pH and 36°C temperature are maintained. The pH is adjusted by sodium hydroxide dosages. Heating is done by steam. The gas generated in the anaerobic treatment reactor is desulfurized, stored in a gas holder, and used for drying products. The effluent from the anaerobic treatment reactor is treated by the activated sludge process and then discharged.

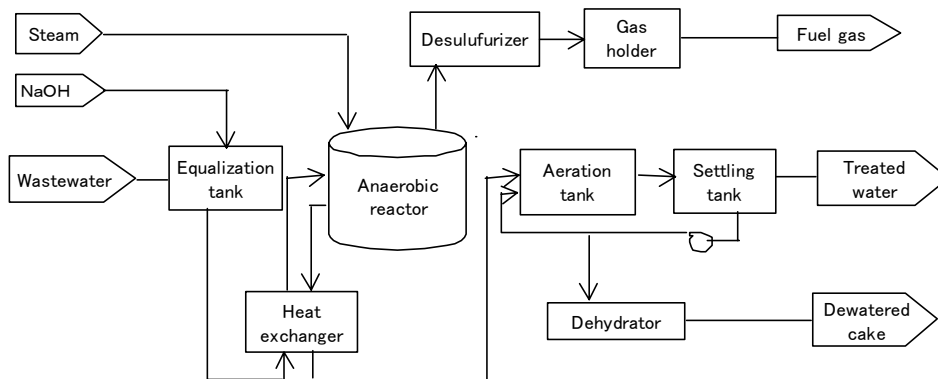

Figure 3-6-2 Schematic flow of wastewater treatment in wheat starch factory

### 3. Performance Results

Start-up of the anaerobic treatment reactor took 3 months due to the slow growth rate of anaerobic microorganisms. Operating data in the start-up period is shown in Figure 3-6-3. During this period, the loads were increased, monitoring the relation between CODcr load input and methane gas volume generation output as well as organic acid concentrations in the effluent. When the load-increase exceeds the growth rate of methanogenic microorganisms, low fatty acids such as acetic acid and propionic acid start to increase. Therefore the load-increase was controlled so that the fatty acid concentrations did not exceed several hundreds mg/l. The treatment results from the anaerobic process are shown in Table 3-6-4. The effluent qualities in the activated sludge process are shown in Table 3-6-5.

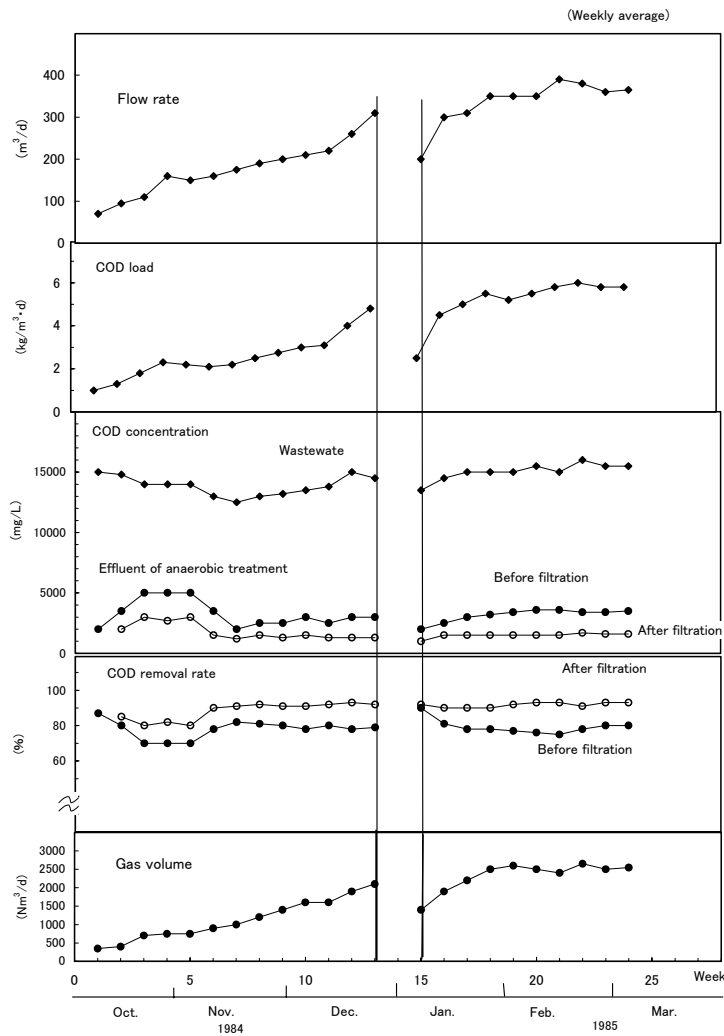

Figure 3-6-3 Operating results at start-up period in anaerobic treatment process

Table 3-6-4 Anaerobic treatment result of wheat starch processing

Items	Apr	Jun	Aug	Oct	Dec	Feb
Wastewater (m <sup>3</sup> /d)	386	359	343	395	400	424
Influent TOC (mg/ℓ)	4,860	5,063	5,350	4,602	5,495	5,382
Effluent (mg/ℓ)	2,252	1,785	1,874	1,650	2,029	2,135
pH	7.1	7.2	7	7	7.1	7.1
Generated gas (m <sup>3</sup> /d)	1,569	1,781	1,810	1,615	2,012	1,688
Methane conc. (%)	67	71	72	71	71	71

Table 3-6-5 Effluent qualities in anaerobic treatment in wheat starch processing wastewater  
(as post activated sludge treatment)

COD (mg/ℓ)	15~56
BOD (mg/ℓ)	22~46
pH	7.0~8.0
T-N (mg/ℓ)	40~70
T-P (mg/ℓ)	60~80

### 6.3 Considerations in Operation and Maintenance (wheat starch)

Though the fixed bed anaerobic treatment reactor is very stable in operation, the media interspace tends to be clogged by microorganisms, and periodic purging with nitrogen gas from the bottom of the reactor is essential. In this operation, peeled anaerobic sludge flows into the aeration tank, and the load on the treatment process increases temporarily. Therefore this purging operation is carried out once or twice a year, during the off-period in summer and/or the end-of-the-year in winter. By introducing the anaerobic treatment for pre-treatment, the bulking problems of the activated sludge process ceased, and sludge settlement in the settling tank was improved, but nitrogen in the effluent increased. The nitrogen, however, was easily reduced by making part of the aeration tank anaerobic or by intermittently stopping aeration.

### 6.4 Example of Actual Treatment (potato starch)

Potato starch processing factories in Hokkaido operate seasonally from the end of summer to early winter. The lagoon process is often adopted because operation start-up is easy, tolerance for load fluctuations is high, and large areas are available in Hokkaido. A typical example is introduced below.

#### 1. Design Condition

Wastewater volume	3,600 m <sup>3</sup> /d
Wastewater qualities	BOD 1,800 mg/ℓ



Effluent qualities	pH	5.8~8.6
	BOD	<120 mg/ℓ
	SS	<150 mg/ℓ

## 2. Process

Wastewater from this starch factory is fed directly into the aeration tank (lagoon) without using an equalization tank. The aeration tank is a pond built by excavating earth with a holding capacity of 30,000 cubic meters. It is equipped with 5 surface floating aerator units of 37 kilowatts, and the detention period is about 8 days. The liquid in the aeration tank is pumped to the settling tank through a flow control device, separated from the sludge, and then discharged as treated water. As the effluent standards for SS is generous, detention time in the settling tank is designed at 6 hours. Settled sludge is returned to the aeration tank similarly as in a usual activated sludge process.

## 3. Performance Results

The operation results for the month of October in the year following the startup are shown in Table 3-6-6. Part of the settled sludge at the bottom of the lagoon is drawn out to use as fertilizer after the suspension of production in early winter, and the lagoon is usually left as it is until startup the next year. The leftover sludge is used for restarting treatment. The average influent BOD and SS at the peak operation in October are 85% and 80% of the design basis. The effluent BOD is always lower than the design limit, although SS exceeds the design limit temporarily due to the carryover of inactive sludge just after restarting. Even when temperature in the aeration tank drops to zero deterioration of the effluent water quality is not recognized, because BOD-MLSS load is designed at the low rate of 0.05 (kg BOD/ kg MLSS · d).

Table 3-6-6 Treatment result of potato starch processing wastewater

Items	Wastewater			Treated water		
	Aver.	Max.	Min.	Aver..	Max.	Min.
Wastewater (m <sup>3</sup> /d)	3,040	3,360	2,760	–	–	–
pH	–	6.8	5.7	–	7.5	7
SS (mg/ℓ)	602	3,730	176	119	188	54
CODMn (mg/ℓ)	939	2,440	409	85	116	60
BOD (mg/ℓ)	1,440	2,230	873	68	91	42
Water temp. (°C)	–	17	2	–	17	2

## 6.5 Considerations in Operation and Maintenance (potato starch)

When septicity of the sludge proceeds due to suspension of activated sludge treatment for a long time, sludge bulking caused by filamentous bacteria tends to occur. This is especially true for potato starch, which contains about 100 mg/ℓ of sulfides that abnormally accelerate the growth of filamentous sulfur bacteria. Due to the abnormal change of the microorganic phase, it takes a long time to restore operations to the original state for restarting operation. The following will prevent this problem. First, provide a minimum level of aeration to control the progress of the sludge septicity. Then store thickened wastewater in the equalization tank and intermittently feed it during suspended operation. When restarting, dose coagulant to coagulate dispersing activated sludge floc so that a minimal concentration of MLSS is maintained by preventing the carryover of floc, and transport sludge from a sewage treatment plant if necessary. Furthermore, it is desirable to start aeration and nutrient dosages, such as remaining wastewater or spent molasses, a few days before restarting treatment in order to acclimatize the activated sludge. If a big load is applied to immature sludge at the initial stage, SS carryover from the settling tank will be heavy. In a lagoon where wastewater is treated by activated sludge, sludge is digested aerobically. The aerobic digestion leads to sludge dispersion and deterioration of sludge settlability, which cause carry-over of SS from the settling tank. If the carry-over of SS is serious, continuous dosing of coagulants to the center well in the settling tank will effectively correct it.

## REFERENCES

1. Murayama, R. Wheat Starch, *The Best Treatment of Food Processing Wastewater Handbook*, p 318 (Science Forum, 2002).
2. Kurokawa, Y. *Water and Wastewater Handbook*, p 784 (Maruzen, 1992).
3. Saiga, K. *Water and Wastewater Handbook*, p 760 (Maruzen, 1992).
4. Higashino, H. *Shinko Pantec Technical Rep.* Vol. 29, No. 2 (1985).

## Chapter 7 Takeout Dishes

### 7.1 Wastewater Volume and Qualities

The size of daily dish processing factories varies in a wide range from relatively small factories that prepare specific dishes to large ones that manufacture 400 products including cakes, breads, and noodles. This chapter introduces a wastewater treatment plant at a large

factory that manufactures various products with only one day off at New Year's Day every year<sup>1)</sup>. The water consumption per unit of raw material varies widely depending on products, so data for each raw material is not obtainable. This factory, for example, uses raw materials of 9,800 tons of flour, 3,600 tons soybeans, and 137 tons alimentary yam paste powder to produce 6,842 tons of noodles, 5,900 tons loaf bread, 4,600 tons sweet bun, 2,700 tons alimentary yam paste, 8,500 tons soy bean curd, and 1,400 tons fried bean curd. The factory uses 350,000 m<sup>3</sup> of water a year, discharging 80% as wastewater. Calculations based on the above-mentioned figures lead to average unit figures of about 20 m<sup>3</sup> per ton of raw materials and about 9 m<sup>3</sup> per ton of products, indicating that this is definitely a water-oriented industry. The production processes of boiling beans, natto, and tamago-tofu (egg-bean curd), which discharge high concentration wastewater, are shown in Figure 3-7-1, and those wastewater qualities are shown in Table 3-7-1.

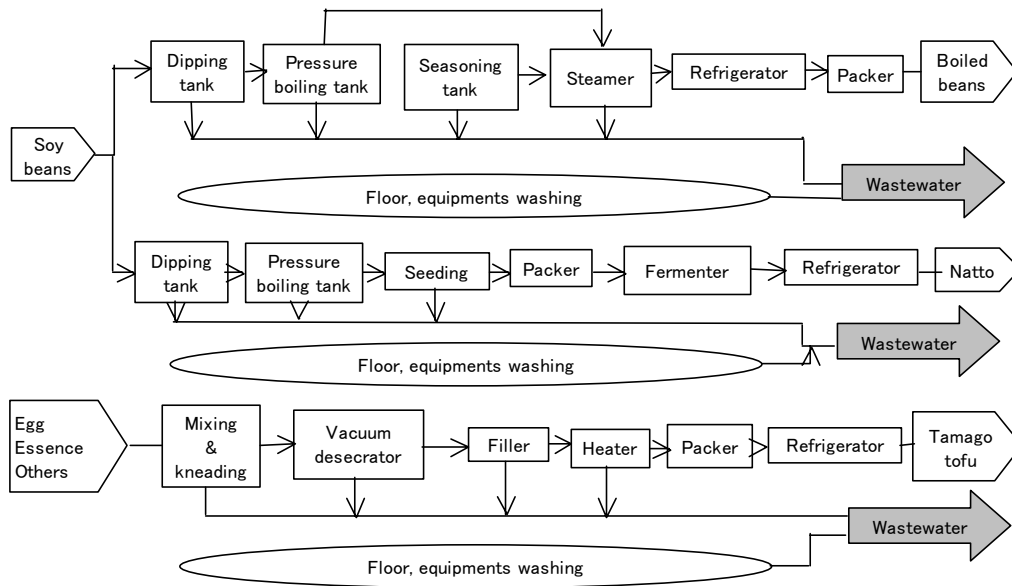

Figure 3-7-1 Schematic flow of large scale daily dishes processing and wastewater

Table 3-7-1 Wastewater qualities in each process in daily dishes processing factory (mg/l)

Items	Tamago-tofu			Natto			Boiling beans		
	High conc.	Middle conc.	Low conc.	Boiling	Submerged	Pot washing	Submerged	Vacuum pot	Cleaning
BOD	6,260	486	82	814	100	117	2,370	358,000	2,220
TOC	3,340	272	29	572	96	90	1,360	222,000	1,470
S-TOC	1,450	175	22	499	93	102	1,290	196,000	780
SS	2,720	143	212	195	5	73	78	675	63
N-hexane extract	4,780	689	<5	<5	<2	<5	<5	6	<5
T-N	438	38	2	84	8	41	52	799	13
T-P	22	4	1	8	1	10	20	152	4

## 7.2 Example of Actual Treatment

### 1. Design Condition

Wastewater volume 1,600 m<sup>3</sup>/d (high concentration wastewater: 1,505 m<sup>3</sup>/d, low concentration wastewater: 650 m<sup>3</sup>/d)

		<u>high concentration</u>	<u>low concentration</u>
		<u>wastewater</u>	<u>wastewater</u>
Wastewater qualities	pH	4.3	6.3
	BOD (mg/l)	2,310	760
	SS (mg/l)	550	130
	n-hexane extract (mg/l)	110	50
Effluent qualities	pH	5~9	
	BOD	<200 mg/l	
	SS	<200 mg/l	
	n-hexane extract	< 30 mg/l	

### 2. Process

As this factory is located in an area where a sewerage system is available, wastewater is collected and treated separately according to high and low concentrations, before being discharged to the sewer, as shown in Figure 3-7-2. The low concentration wastewater is screened of floating large solids, treated through coagulation dissolved flotation process, neutralized, and then discharged. The high concentration wastewater is also screened of floating large solids and goes through the equalization tank and heat exchanger to the anaerobic treatment reactor. The anaerobic treatment reactor is equipped with floating plastic media inside and kept at 7 pH and about 36 °C. The pH is adjusted by sodium hydroxide. Heating is provided by steam. Methane gas generated in the anaerobic treatment reactor is desulfurized, stored in a gas holder, and used for drying products. The effluent from the anaerobic treatment reactor is treated by the aerobic biological treatment plant with floating media. At the next step, in order to remove SS peeled off from the media surfaces and SS in influent raw wastewater, the effluent is coagulated by ferric chloride and polyelectrolyte, treated in a DAF unit and, after pH adjustment, discharged into the sewer.

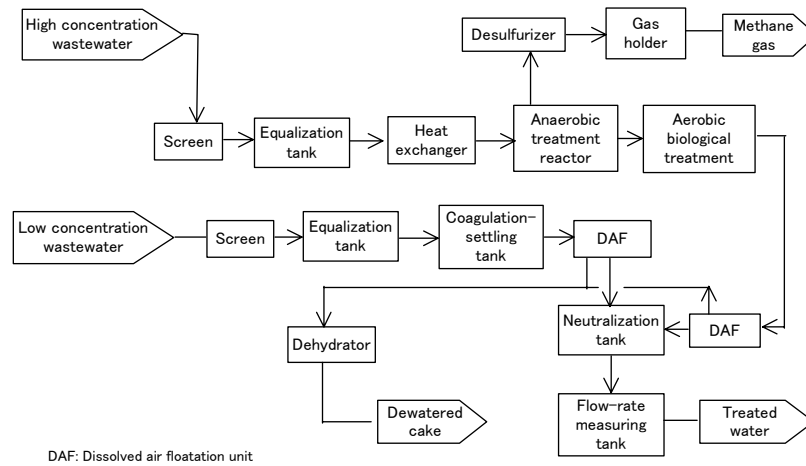

Figure 3-7-2 Schematic flow of wastewater treatment in daily dishes processing (discharge to sewer)

### 3. Performance Results

The raw wastewater quality data, averaged for every half month throughout a year, are shown in Figures 3-7-3 and 3-7-4 for the high and low concentration wastewater. The seasonal changes of quality, designated as the ratio of maximum to minimum, are 2 times for BOD and 3 times for SS, concerning both high and low concentration wastewater. Figure 3-7-5 shows the performance of the high concentration treatment system incorporated with advanced treatment process, indicated by one year's average of BOD through the sequential steps. As seen in the figure, 1,860 mg/l in raw water is reduced to a stable 650 mg/l by anaerobic treatment, then to 250 mg/l by latter bio-film aerobic treatment, and finally to 6 mg/l by coagulation-floatation. This effluent is mixed with treated water of low concentration wastewater and discharged into the sewer. The quality is shown in Figure 3-7-6.

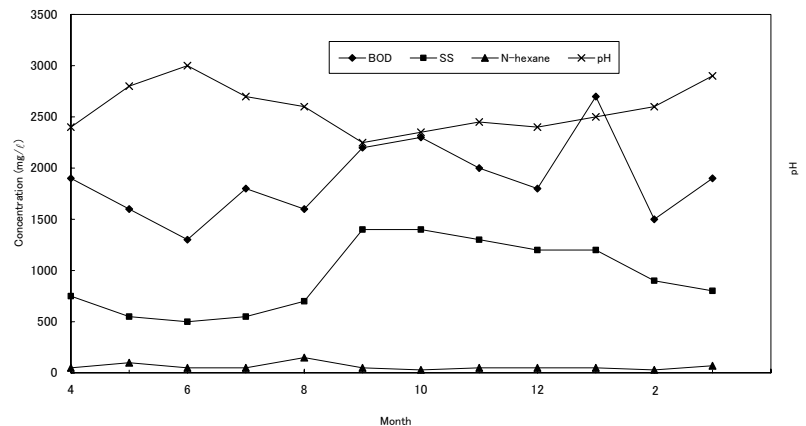

Figure 3-7-3 Yearly variations of wastewater in takeout dishes factory (high concentration stream)

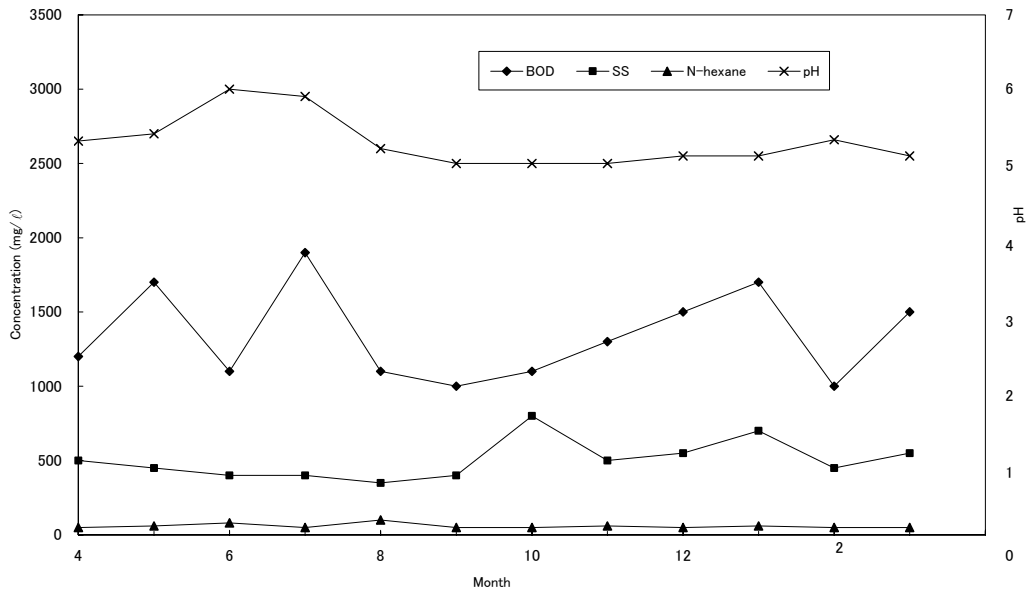

Figure 3-7-4 Yearly variations of wastewater in takeout dishes factory

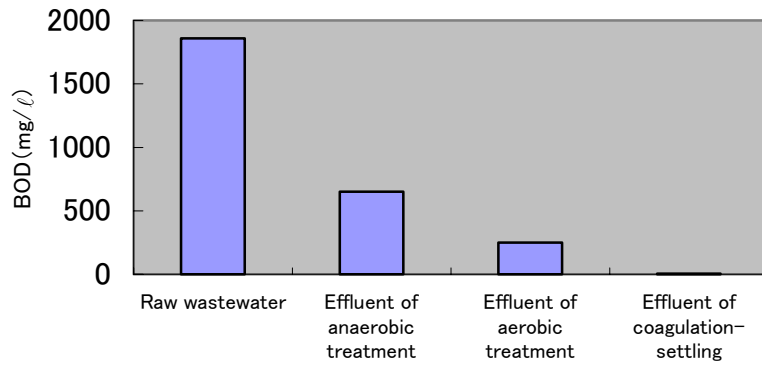

Figure 3-7-5 Treatment result of high concentration wastewater

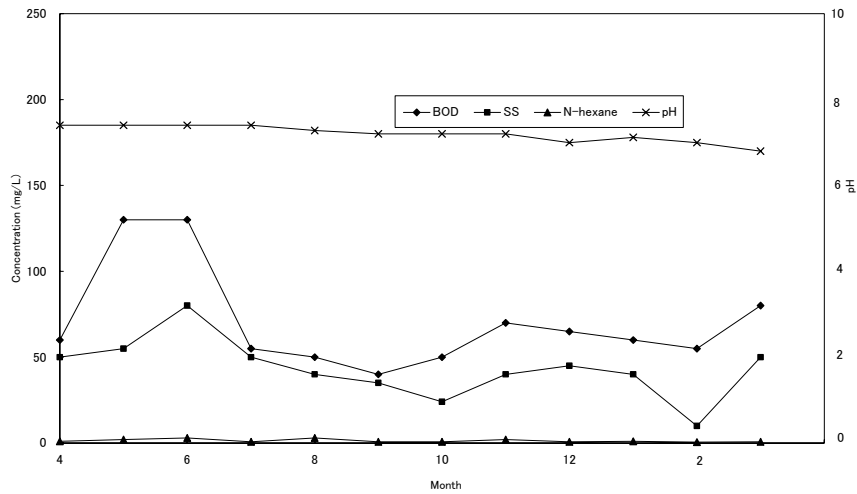

Figure 3-7-6 Wastewater treatment result in takeout dishes factory

### 7.3 Considerations in Operation and Maintenance

Detergents and disinfectants are used for cleaning equipment in food processing factories. If these chemicals are overused due to mistakes or leaks, it causes abnormal foaming in the anaerobic and aerobic treatment plants. As disinfectant leakage temporarily decreases biological activity of the anaerobic and aerobic treatment plants and deteriorates the effluent quality, serious attention must be paid to such leakage. As the deposited solids at the bottoms of tanks go rotten and emit offensive smells, periodical cleaning of the wastewater pits, equalization tank, DAF, and other items are desirable.

### REFERENCES

1. Soejima T. Daily Dishes, *The Best Treatment of Food Processing Wastewater Handbook*, p 318 (Science Forum, 2002).

## Chapter 8 Confectionaries

### 8.1 Wastewater Volume and Qualities

The wastewater properties in confectionary factories vary widely depending on the products and are also influenced by seasonally changing demands. This chapter introduces wastewater treatment processes for jellied fruit and sponge cake (Castella) factories<sup>1)</sup>. Jellied fruit is jelly with pieces of fruit such as loquats, oranges, and peaches inside. To make it, liquid sugar, syrup, flavor, and pigment are blended, and the mixture is filled into cups filled with pieces of fresh fruit. The main streams of wastewater are from washing the equipment, syrup spilling from opened cans, and overflows of blended liquor from sealing machines. Figure 3-8-1 shows the production process of jellied fruit and the wastewater sources. Sponge cake (Castella) is made in a way that raw materials of egg, sugar, flour, and other ingredients are blended and baked in a baker. Then, the baked cake is packed in a wooden box. The Castella production process is in Figure 3-8-2. The main streams of wastewater are from washing the egg-crusher, blender, filler, and wooden box.

### 8.2 Example of Actual Treatment

#### 1. Design Condition

Wastewater volume		160 m <sup>3</sup> /d
Wastewater qualities	BOD	4,000 mg/ℓ

	COD <sub>Mn</sub>	2,500 mg/l
Effluent qualities	BOD	10 mg/l (daily average)
	COD <sub>Mn</sub>	20 mg/l (daily average)

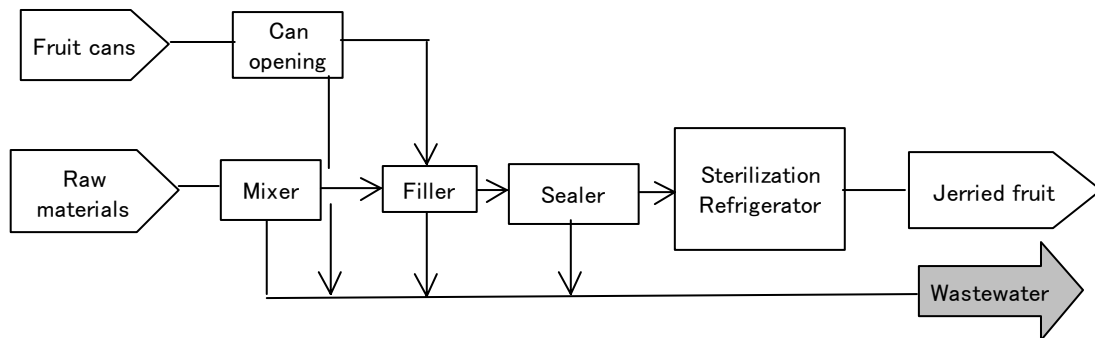

Figure 3-8-1 Schematic flow of Jerried fruit processing and wastewater

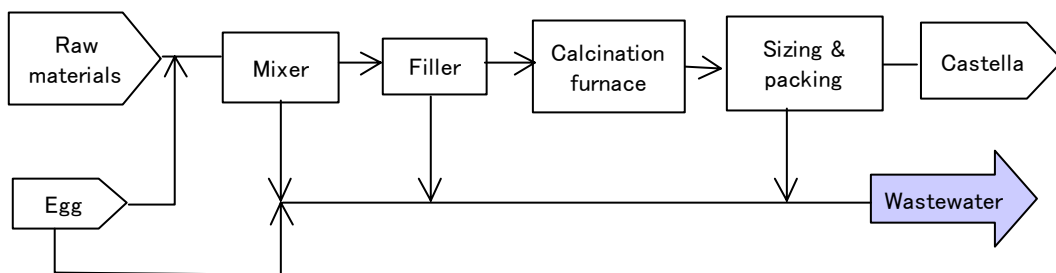

Figure 3-8-2 Schematic flow of Castella processing and wastewater

## 2. Process

As this factory is located in an area where the effluent standards are strict, the wastewater is treated in two stages, which are a conventional activated sludge process and an aerobic biofilm process. A coagulation-sedimentation tank is provided to cope with emergency cases involving effluent quality deterioration. The schematic flow diagram is shown in Figure 3-8-3. The influent wastewater is adjusted to equalize the flow rate in the equalization tank and dosed with nitrogen and phosphorus to cover shortage. Then, it is fed into the aeration tank and separates the sludge in the settling tank. After further removal of BOD and COD<sub>Mn</sub> in the contact stabilization tank, the wastewater goes through the coagulation-sedimentation tank for emergencies, and it finally flows out after chlorination. To prevent sludge bulking, a 10 stage plug-flow is provided for the aeration tank. Excess sludge is thickened in the thickener, stored in the sludge storage tank, periodically dewatered by a mobile dehydrator on a truck, and then carried out.



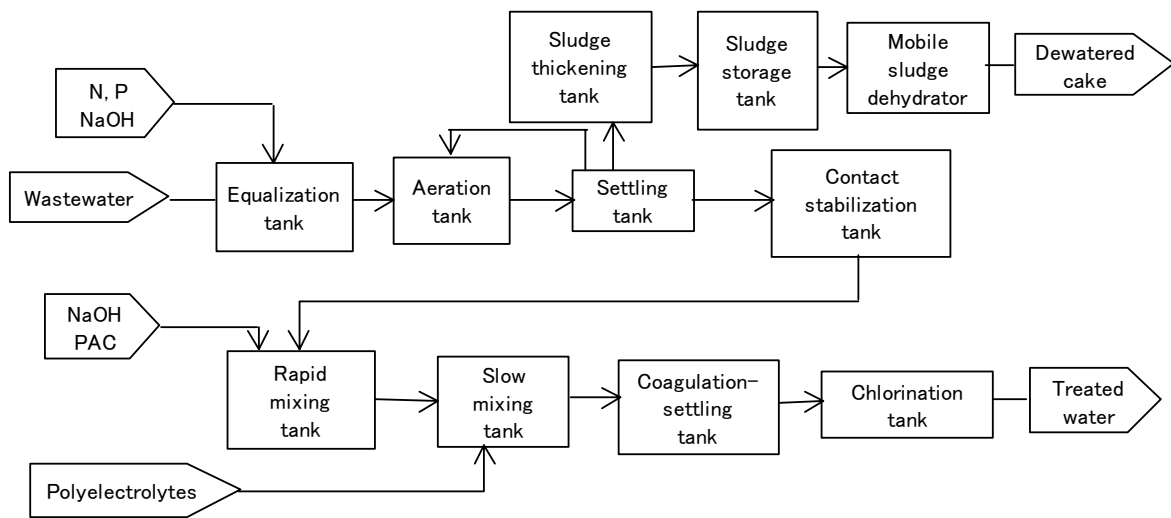

Figure 3-8-3 Schematic flow of confectionary factory wastewater treatment

### 3. Performance Results

This wastewater has major seasonal fluctuations in volume and concentration. Although BOD in the outflow of the equalization tank fluctuates from 2,000 to 4,500 mg/l, BOD 5~30 mg/l and COD<sub>Mn</sub> 20~40 mg/l are maintained in the effluent from the settling tank. There have not been any emergencies using the coagulation-sedimentation tank. The nutrient balance in the wastewater is BOD: N: P=100: 0.4: 0.1 for the jellied fruit factory and BOD: N: P=100: 0.2: 0.1 for the Castella (sponge cake) factory. As these figures show, nitrogen and phosphorus are short in both cases. Instead of using chemical compounds, however, treated water from the septic tank for domestic sewage in the factory is mixed into the wastewater, as it contains both nitrogen and phosphorous. In addition, saving operation costs and preventing eutrophication have been achieved by managing the dosages of nitrogen and phosphorous based on the data of relations between the BOD-sludge converted ratio and the nutrient requirements. For instance, if the BOD-sludge conversion rate decreases below 0.2 in normal operation, no nutrients are dosed.

### 8.3 Considerations in Operation and Maintenance

Viscous sludge bulking generally tends to occur in wastewater containing much saccharide, due to the accumulation of polysaccharide, and it makes separating the sludge difficult in the settling tank. Measures to prevent bulking in the aerobic treatment of wastewater from factories making cake, bread, fruit juice, and other products are conceivable in

relation to two aspects. The first aspect related to the equipment is introducing the plug-flow to the aeration tank which causes the gradient of BOD concentration and also introducing a batch-wise activated sludge process involving partial anaerobic process. The second aspect related to the operation is adjusting the MLSS concentration to maintain an appropriate BOD-MLSS load ( $0.2\sim 0.4 \text{ kg BOD/kg MLSS} \cdot \text{d}$ ) to delay the growth rate of bulking-exciting filamentous microorganisms and to adjust the DO concentration in the aeration tank within an appropriate range. Actually, in this plant, bulking has been successfully prevented since it adopted plug flow and tapered aeration for keeping a determined level of DO concentration at each stage in the aeration tank. In the aerobic biofilm process in the second stage, bulking-exciting filamentous microorganisms are attached, held by the media, and prevented from flowing out to the settling tank. It is also considered effective.

## **REFERENCES**

1. Ohnishi M. Confectionary, *The Best Treatment of Food Processing Wastewater Handbook*, p 351 (Science Forum, 2002).